

flexorTM 500

IP Telephone
User Manual

Issue 1.5
03/04/2007

The Flexor device, CamrivoX and the CamrivoX device are registered trademarks of CamrivoX Ltd. All other trademarks acknowledged.

Copyright © 2007 CamrivoX Ltd, all rights reserved. The contents of this publication may not be reproduced in any part or whole, transcribed into any language, or transmitted in any form or by any means, electronics, mechanical, magnetic, optical, chemical, photocopying, manual, or otherwise, without the prior written permission of CamrivoX Ltd.

Table of Contents

	IP Telephone User Manual	1
1	Introduction	6
	Using this Document	7
2	Safety information	8
	Safety advice	8
	Emergency calling	8
3	Getting to know the device	9
	Parts check	9
	Buttons and LED indicators	10
	Display	12
	Ports and connections	14
4	Configuring the device	15
	Installing the software	15
	Connecting the hardware	15
	Configuring the Flexor 500	17
	Testing your setup	20
5	Making and receiving phone calls	22
	Receiving calls	22
	Making calls	22
	Ending calls	26
	Volume	26
	Making calls (using CTI via an attached PC)	26
6	Using advanced phone features	28
	Putting a call on hold	28
	Transferring calls	28
	Do-not-disturb	30
	Call divert	30
	Forward busy	31
	Forward unanswered	31
	Reject anonymous calls	31
	Conference calls (3 Way Calls)	32
	Voicemail	33
	Call list	33
	Call Waiting	34

7	Managing the device from the menus	35
	Network settings	35
	Quality of Service	36
	Region	37
	Screen	38
	Volume	38
	Ringer	39
	SIP accounts	40
	Firmware	40
	VLAN	42
	Diagnostics	43
8	Managing the device using web pages	44
	Accessing the Web pages	44
	Web pages overview	45
	Managing accounts	46
	Setting a region	48
	Viewing the call history	49
	Using the address book	49
	Call management	51
	Flexor 500 Status	53
9	Advanced configuration options	54
	Voice settings	54
	QoS (Quality of Service) settings	55
	Network settings	56
10	LAN Provisioning	58
	Introduction	58
	DHCP server configuration	58
	Configuration File specification	59
	LAN Provisioning error codes	61
11	Troubleshooting	62
	Resetting to factory defaults	62
	Upgrading the firmware	63
	Diagnostic messages	65
12	Installing the Voice Connect application	68
	About the Voice Connect software	68
	Installing the Voice software	68

	Uninstalling the software	72
13	Specification	73
14	Copyright notices	74
	Camrivox.....	74

Table of Figures

Figure 3-1 - Flexor 500 LEDs and Buttons	10
Figure 3-2 – Example of a typical screen	12
Figure 3-3 - Flexor 500 Rear Connectors and Connections	14

1 Introduction

Congratulations on becoming the owner of the Flexor 500. You will now be able to make low-cost phone calls over the Internet.

A standard telephone connects to a telephone line and allows you to make and receive calls over the PSTN network. These types of calls are known as **PSTN calls**.

With the Flexor 500 installed, you are still able to receive PSTN calls. When you make calls these are directed over the Internet; these types of calls are known as **VoIP calls**.

To you as a user there is really no difference between making calls over the Internet or calls over the PSTN network. The difference to you is in the cost of the calls. VoIP calls are much cheaper than PSTN calls.

The Flexor 500 can receive calls from both Internet and PSTN sources. Calls are made over the Internet and can be to both VoIP and PSTN destinations.

It is possible to configure up to four separate telephone lines so that several calls can be managed simultaneously.

The Flexor 500 has an hands free speaker and microphone (built in) and a connector for an external headset (not provided).

In addition to providing low-cost calls, the Flexor 500 is packed with enhanced phone features, including:

CTI (Computer Telephony Integration) that enables you to integrate your phone with your PC, for example, synchronizing your Microsoft Outlook address book with the Flexor 500.

Advanced phone functions such as Call Transfer, Call Hold and Three Way Calling.

This User Guide will show you how to connect up and start using all the features provided by the Flexor 500.

Using this Document

Typographical conventions

- ◆ *Italic* text is used for items you select from menus and drop-down lists and the names of displayed web pages.
- ◆ **Bold** text is used for text strings that you type when prompted by the program, and to emphasize important points.

Special messages

This document uses the following icons to draw your attention to specific instructions or explanations.



Note

Provides clarifying or non-essential information on the current topic.



Warning

Provides messages of high importance, including messages relating to personal safety or system integrity.

Getting Support

For customer support please contact the company that supplied your Flexor 500 product.

User manual and other updates can be found at:

<http://www.camrivo.com/support/index.html>

2 Safety information

Safety advice

For your safety, please adhere to the following safety instructions:

Do not obstruct the ventilation holes of the Flexor 500, or place anything on top of it.

Place the Flexor 500 on top of a smooth, flat surface such as a table-top.

Do not open the Flexor 500. This voids the warranty.

Only use the provided power supply.

If the device or power supply appears damaged, do not use them and contact your supplier for a replacement

Keep your unit dry, out of direct sunlight, and away from sources of heat.

Emergency calling

While the Flexor 500 contains features designed to facilitate emergency calling, CamrivoX Ltd. does not guarantee it is suitable for this purpose and is not liable for any failure to contact the emergency services. Users should ensure they have a secondary system with which they can make emergency calls.

3 Getting to know the device

Parts check

Your package should arrive containing the following:

1. Flexor 500 body
2. Handset
3. Handset cable
4. Ethernet cable
5. Power Supply
6. Voice Connect CD

1.

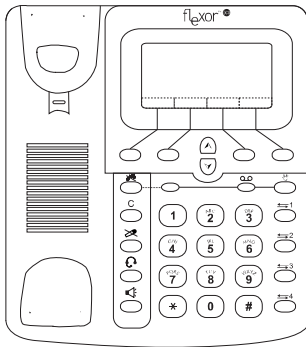

2.



3.

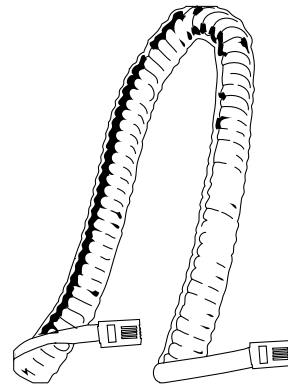

4.



5.

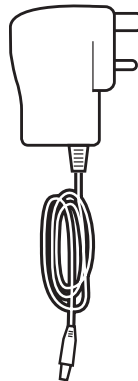

6.



Buttons and LED indicators

The Flexor 500 contains a number of buttons and lights called Light Emitting Diodes (LEDs) that indicate the status of the unit.

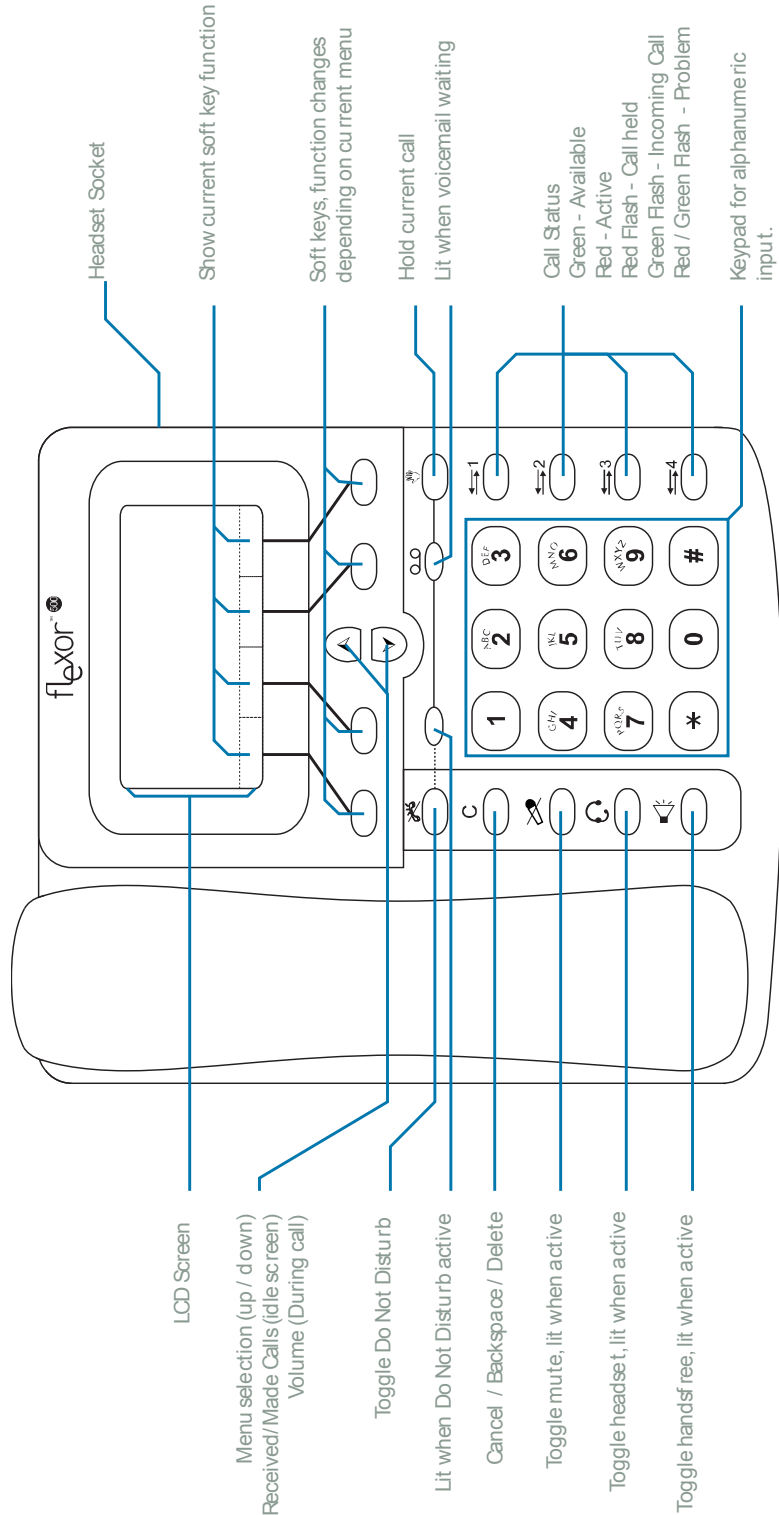



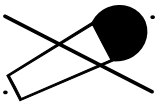

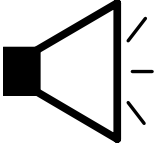
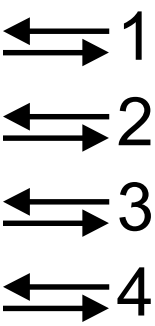

Figure 3-1 - Flexor 500 LEDs and Buttons

Indicator	Type	Function
	Button / LED	<p>Do not disturb button.</p> <p>Pressing this directs all incoming calls to your voicemail. This can be useful on occasions when you do not wish to be disturbed, or when you are away but expecting an important call and wish to check the message remotely (through your VoIP provider's voicemail system).</p> <p>Directing calls to voicemail diverts calls immediately, i.e. the telephone will not ring at all.</p> <p>The LED is illuminated red when the phone is set to divert calls to voicemail.</p> <p>See <i>Voicemail</i> on page 33 for additional information on voicemail configuration.</p>
	LED	<p>Message waiting indicator.</p> <p>This indicator is illuminated red when there are new voicemail messages waiting. See page 32 for details of accessing voicemail.</p>
	Button	<p>Hold button.</p> <p>Puts the current call on hold. Press this again to return to the call.</p>
	Button / LED	<p>Mute button.</p> <p>Pressing this mutes the audio. The button is illuminated when the audio is muted.</p>
	Button / LED	<p>Headset button.</p> <p>This button selects the (optional) headset for audio. The LED is illuminated when the headset is in use.</p> <p>Press this to answer an incoming call using the headset or to hang up any call using the headset.</p>
	Button / LED	<p>Speakerphone button.</p> <p>This button selects the speaker and microphone for audio. The LED is illuminated when the speaker is selected.</p> <p>Press this to answer an incoming call using the speaker or to hang up any call using the speaker.</p> <p>If the headset or the handset is in use then pressing this switches the audio to the speaker.</p>
	Button / LED	<p>The Flexor 500 supports up to four telephone lines. The buttons are used to switch between these.</p> <p>The LED is:</p> <ul style="list-style-type: none"> • Solid green when line available • Flashing green when incoming call • Solid red when line in use/on call • Flashing red when on hold

C	Button	Cancel. Aborts current operation or deletes last character from entered data. During a call this disconnects the current call.
0-9, *, #	Buttons	Standard telephone keys.
Up, Down	Buttons	Used for menu navigation and to set the volume during a call. Access call history from idle state.
Soft keys	Buttons	These are the four buttons below the display. The use varies but is indicated with the bottom line of text on the display.

Display

The Flexor 500 has a display that can show up to six lines of text. Figure 3-2 shows a typical display.



Figure 3-2 – Example of a typical screen

The first line of text on the display describes the current screen. This has light text on a dark background and is referred to as the *title bar*.

The bottom line of the screen has text that relates to four of the buttons. These buttons are referred to as the *Soft Keys* in this document. These are used for different purposes in the various screens. In the current example only two of the four soft keys have functions associated with them.

Data Input

The numeric keys are used in various modes. In some cases they are simply used for entering numbers, in other cases they are used to enter text.

The title bar shows an icon on the left to indicate how the numeric keys are currently used.



Icon	Function
None	The numeric keys are not used.
123	Numeric keys are used to enter digits. The cancel button can be used to delete the last digit. Note that numeric entry has a maximum value so that further keys will not be accepted if the numeric value would be

	too large.
ABC	Numeric keys are used to enter text in uppercase. Keys are pressed repeatedly to cycle through the characters on a particular key.
abc	Numeric keys are used to enter text in lowercase. Keys are pressed repeatedly to cycle through the characters on a particular key.
010	Numeric keys are used to enter binary. Only 0 and 1 will be accepted.
#*@	A table of symbols is provided to allow other characters to be entered.

In the text entry modes the # key is used to switch between upper and lower cases. The * key switches to a table of symbols to allow non-text characters to be entered. Spaces are entered using the 0 key.

Audio Source

In a similar way to the data entry mode there are icons shown on the right of the title bar. These are used to indicate the currently active audio source.

Icon	Function
None	No audio active
	Audio uses the speaker.
	Audio uses the headset.
	Audio uses the handset.

The audio source is also shown using the headset and speaker LEDs when these are active.

Back light

There is a backlight feature for the display that is designed to make it easier to see in some conditions. The light is activated when the phone is being used for making a call or the menus are being navigated and switches off automatically to save power.

The brightness can be altered or the light disabled and this is described in *Screen* on page 38.

Ports and connections

The rear panel contains the ports for the unit's data and power connections.

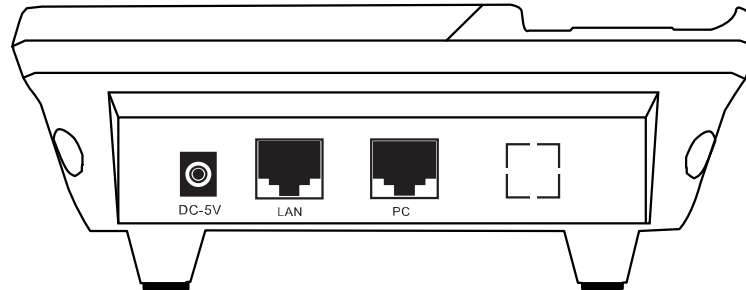

Figure 3-3 - Flexor 500 Rear Connectors and Connections

Socket	Function
DC 5V	Connects to the power supply using the supplied power cable.
LAN	Connects to your LAN Ethernet switch using the supplied Ethernet cable
PC	Connects to your PC using an Ethernet cable.

The handset is connected to the right side of the device using the cable provided.

In addition to the rear panel there is a connector on the side for a headset. This takes a 2.5 mm. jack plug with the wiring (starting from the tip) as follows.

- Microphone
- Speaker
- Ground

4 Configuring the device

This chapter provides basic instructions for connecting the Flexor 500 to your PC and to the Internet and instructions on configuring the device.

This chapter assumes that you have already established a broadband service with your Internet service provider (ISP) or have an Internet connection via a LAN. These instructions provide a basic configuration that should be compatible with your home or small office network setup. Refer to the subsequent chapters for additional configuration instructions.

Installing the software

It is highly recommended that the Voice Connect application is installed before connecting the device. This provides additional features and helps with configuring the Flexor 500.



Note

For more information on the Voice Connect software, see [Installing the Voice Connect application on page 68](#).

Connecting the hardware

This section describes how to connect the device to the power outlet and your computer(s) network.

The single-page Installation Sheet provided in the packaging with the Flexor 500 should be referred to for instructions and help on cabling.

For detailed connection information see [Figure 3-3 - Flexor 500 Rear Connectors and Connections on page 14](#).

If your LAN Ethernet switch has a spare connection then connect the Ethernet cable from this connection to the LAN port on the Flexor 500.

If there is no spare connection then unplug your PC from the network and connect the cable from the LAN Ethernet switch to the Flexor 500 LAN port. Connect another cable from the Flexor 500 PC port to your PC network card.

It is important that the PC and the Flexor 500 are on the same local network.

The steps to follow to connect the Flexor 500 are described below.

Step 1. Connect the Ethernet cables and handset

Connect the provided Ethernet cable from a network connection to the LAN port on your device.

If you require a network connection for a PC and your network router does not have a spare connection then connect your PC to the PC socket on the Flexor 500 using another Ethernet cable.

Connect one end of the handset cable to the socket on the left side of the Flexor 500 base and the other end to the handset.

Step 2. Attach the power connector

Connect the AC power adapter to the Power connector on the back of the device and plug the adapter into a wall outlet or power strip.



Warning

Only use the power adapter that is supplied with the device.

Turn on the power to the Flexor 500. The Flexor 500 will start up and assuming it is connected to your local area network via an Ethernet cable it will try to determine the settings to work with your network.

The display on the Flexor 500 shows the progress of this process. It initially shows the Flexor logo and then shows a screen similar to the one below. During this process the line LEDs will flash, alternating between red and green.

There are four stages to the process to detect settings. Each stage shows "OK" when it has passed or "Fail" if an error occurs. The section Troubleshooting on page 62 provides details of what to do if this occurs.

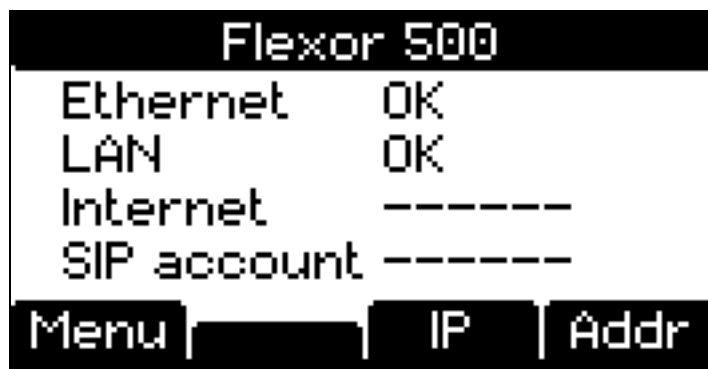

The Ethernet stage indicates whether the network cables have been connected. LAN indicates whether a local network has been detected and a valid address configured. Internet shows whether a connection to the external Internet has been established. The SIP account represents whether a voice account has been configured and validated with the remote server.

If the process is successful the screen will show the current time as shown below.

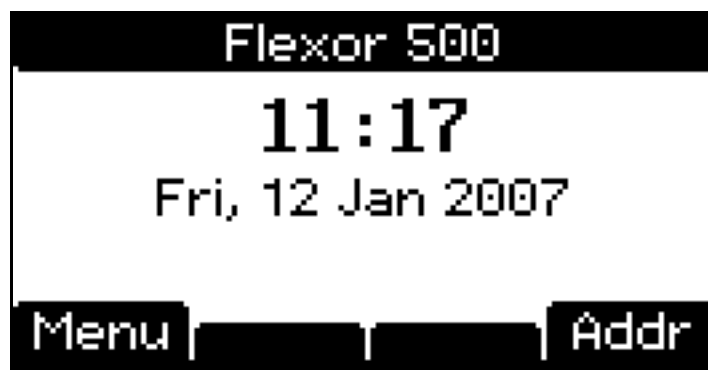

Once this screen is shown it should be possible to make calls.

If you wish to manually change the network setting see section *Network settings* on page 35 for more information.



Note

If your Flexor 500 has been supplied to you by your Voice Over IP Operator or ITSP then you probably do not need to configure the device. Once connected correctly the Flexor 500 will configure itself automatically with your operator's settings enabling you to make calls straight away. If this is not the case see *Configuring the Flexor 500* below.

If the device has not been supplied configured by your ITSP then the process will stop at the SIP account stage and then display a screen with the management web page details.

The web page URI has the form shown but the exact address depends on your network settings.

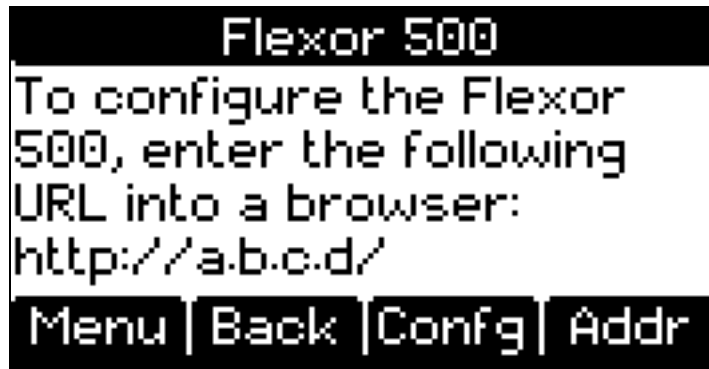

In this case the device needs to have the account configured from the management web pages as described below.

Configuring the Flexor 500

This section describes how to configure the Flexor 500 using the Flexor 500 management web pages. Follow **Step 1b** if using VoiceConnect, else follow **Step 1a**.

Step 1a. Accessing the web pages without using VoiceConnect

If you have not installed the Voice Connect application, you will need to find the URL used to access the Flexor 500 management web pages.

The management web page address can be found by pressing the *IP* soft key during the start up process or from the *IP Address* option on the main menu.

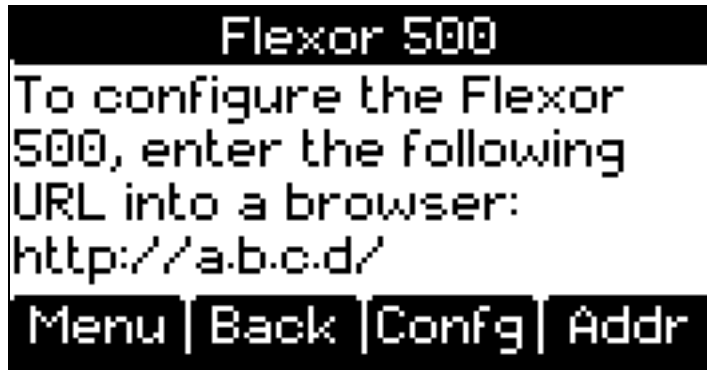

This shows the IP address assigned to the phone which can be entered into the browser.

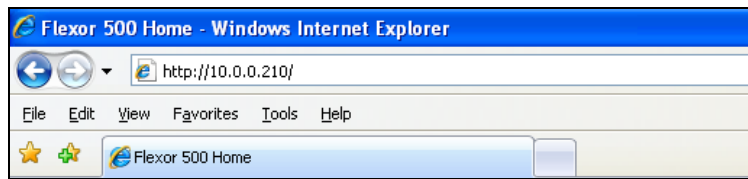

The exact address may vary but should have a similar format to the one shown.



Note

If you have problems with either steps 1a or 1b, or when picking up an attached telephone handset you hear a diagnostic message, please see [Troubleshooting](#) on page 62.

Step 1b. Accessing the web pages using VoiceConnect

Assuming VoiceConnect application from the supplied CD is installed and running, once the Flexor 500 and PC are on the same network and powered-up, the following dialog box will be displayed after a short time (up to 30 seconds):

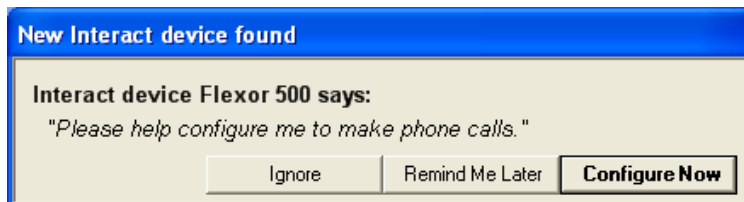

Click on **Configure Now**.

Step 2. Configuration pages

Having followed step 1a or step 1b you should now see a web page displaying the Flexor 500 management web pages:

Messages Fri, 26 Jan 2007 - 12:29 GMT [Change](#)

 **Flexor 500** is connected to the Internet, however no voice service provider is configured. This wizard will help configure the **Flexor 500** for your service provider.

Flexor 500 Configuration Wizard

Flexor 500 has detected your country or region as **United Kingdom**.

If you are happy with this setting click **Next** else select a country or region below and click **Next**.

Region or country:

Click [here](#) to see the current configuration.

For advanced users - if you wish to skip the wizard click [here](#).

There is a message area towards the top of the page that shows the current status. If your telephone has not been configured then the message area shows a warning that a service provider has not been selected. The bottom part of the page is then used for a configuration wizard to set your user account.

Step 3. Select your country

The first task is to select your country. The Flexor 500 will attempt to automatically detect which country you are in as shown below:

Flexor 500 Configuration Wizard

Flexor 500 has detected your country or region as **United Kingdom**.

If you are happy with this setting click **Next** else select a country or region below and click **Next**.

Region or country:

Click [here](#) to see the current configuration.

For advanced users - if you wish to skip the wizard click [here](#).

If you wish you can override this setting by choosing an alternative country from the **Region or country** pull-down menu. Once you are happy with your country selection, click on **Next >**.

Step 4. Configure your VoIP account

Now you must configure your VoIP account settings so that you can make VoIP calls over the Internet:

Flexor 500 Configuration Wizard

Please select a service provider from the following list:

The list only shows **United Kingdom** service providers. Click [here](#) to see a full list, or if you wish to enter manual settings click [here](#).

Choose the name of your ITSP (Internet Telephony Service Provider) from the list box.



Note

If your ITSP is not displayed in the list box, click on the [here](#) link to enter your settings manually. Refer to [Managing accounts on page 46](#) for more information.

Click on **Next** >. Now enter your VoIP account details:

Your ITSP should have provided you with a user name and password, either by email or by post. Enter these details along with (optionally) your own name.

Click on **Finish**. A message is displayed briefly, informing you that the device is contacting your ITSP to verify your account details.

Click on **Return Home**. The home page is displayed with a message informing you that the device is connected and working properly:

Setup complete

The above steps are the only configuration tasks that are required in order to begin using your Flexor 500. You should now be able to make telephone calls.

For more information about the Flexor 500 management web pages refer to *Managing the device using web pages* on page 30.

Testing your setup

Once you have connected the device and configured it you should check the following to ensure that everything is working correctly.

Firstly, if the time is shown correctly this indicates that the device has managed to access the internet to read the current time.

When your telephone is configured with a valid ITSP at least one of the line buttons should be illuminated in green. This indicates that you have a line available to make and receive calls.

If there is a PC is connected through the PC port on the device, test the Internet connection from this PC. To do this, open a web browser, and type the URL of any external website (such as <http://www.yahoo.com>).

Make a test telephone call to see that all is working. Refer to *Making and receiving phone calls* on page 22 for details.

If any of the above checks have failed, then refer to Troubleshooting on page 62 for more information.

5 Making and receiving phone calls

This chapter describes how to use the Flexor 500 to make and receive phone calls.

Receiving calls

Receiving phone calls on the Flexor 500 is extremely straightforward, but there are some features to note:

The line indicator will flash to indicate which line the incoming call is received on.

The number of the caller (and possibly the name) will be displayed on your telephone. If the number of the incoming call is in your address book, the Flexor 500 automatically converts the number to the name in your address book.

If the Flexor 500 *Do Not Disturb* button has been pressed then the incoming call will be redirected immediately and the telephone will not ring. (See *Buttons and LED indicators* on page 10 for further details).

If Call Divert or Voicemail has been setup from the management web pages or menus (but the *Do Not Disturb* button has not been pressed), then the call will be redirected. The redirection will occur after a user-specified number of seconds. (See *Call management* on page 51 for further details.)

If a call is received in the middle of another call (with the call waiting feature enabled), the screen will show the incoming number (and possibly the name) and the line button for the incoming call will flash green. You can switch between the two calls using the line buttons.

Making calls

This section describes how to use the Flexor 500 to make outgoing calls. Various methods are provided.

Dialling directly

The simplest way to call somebody is to dial the number directly. When making a call the following points should be noted:

- ◆ To dial another VoIP extension using a telephone number simply dial the number.
- ◆ When calling a land-line number always remember to prefix it with the area code (even if the number is a local number).
- ◆ A SIP URI can be entered by pressing the *SIP* soft key from the dialling tone. This enters a mode to allow a SIP address to be entered as text.

To get a dialling tone lift the receiver, or press the speakerphone or headset button.

The display shows the dialled digits as they are entered. If an incorrect digit is pressed then the *C* button can be used to delete the last digit.



After entering the digits for the number press the *Call* soft key to dial the number.

A set of valid number formats and lengths may have been configured based on your region by your service provider. The number will be dialled automatically when a recognised pattern has been entered. Some patterns are dialled immediately (typically full numbers with area code) while others may be dialled after a few seconds delay.

Using the contacts list

The Flexor 500 has an built in address book. The entries in this can be synchronized from Microsoft Outlook using the Voice Connect application. Entries can also be added using the Flexor 500 web pages and from the call history from an incoming call.

The address book is held in permanent memory within the device and is able to hold up to 300 entries. The web pages provide an alternative interface to the same list of names.

To make a call using the address book first lift the receiver or press the hands free button to get a dial tone. Press the *Addr* soft key to view a list of your contacts.

The screen shows up to three names with one highlighted name. Use the up / down keys to scroll through the list.



Each name can have up to three numbers associated with it. These are marked as Home (H), Work (W) and Mobile (M). Scroll between the numbers for the selected name using the * key.

Press the *Call* soft key to dial the highlighted number.

Selecting names

It is possible to search the list of contacts in two different ways.

The quickest method is to type the first few letters of the name using the numeric keys. These behave in a similar way to predictive text on a mobile telephone.

The search tries to match the first part of each name so that you can search using the first name or the surname.

Suppose you wished to search for Charles Jones. The predictive text letters for Charles relate to the numbers 2 then 4. The screen highlights any possible matches by underlining the matching part of the name as in the example below.

It would also be possible to search on the surname by pressing 5 and then 6 for "JO"



In this case there are three possible matches. Pressing another number to match the third letter immediately reduces the list to the single match.

If you type the wrong number and there are no matches then press the *Cancel* button to reduce the length of the search string.

It is also possible to enter a separate screen to allow a text string to be entered. This is done using the *Search* soft key from the contacts list. A new screen is displayed where text can be entered using the standard text entry method used on most mobile telephones.

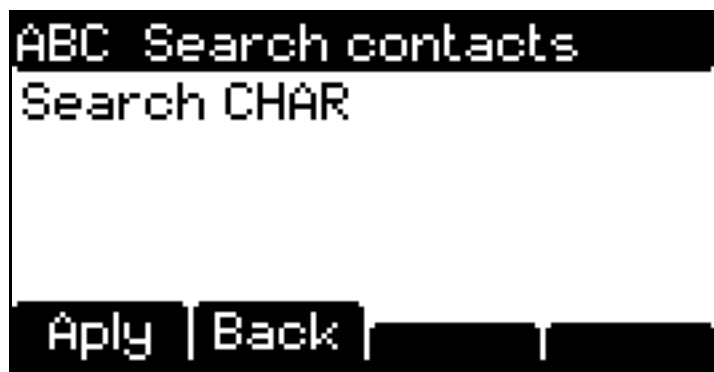

Press the *Apply* soft key to use the search string. The cancel key can be used to delete letters from the search string.

Call history

The Flexor 500 holds lists of recent calls received and made. A maximum of 60 calls can be stored. These are held in temporary memory and will be lost if the device is reset.

The call lists are accessed through the *Call History* menu item on the main menu. This leads to a screen with a list of different types of calls.



There are five options on this menu. The first three provide access to lists of the missed, received and outgoing calls. There is also a list of all of the calls and an option to clear the call lists.

The lists are presented with one entry on the screen. The up / down keys are used to go to the previous and next entries in the list. Each entry shows the number dialed and the name (if this was found in the address book) plus the date and time of the call.

The soft keys provide options to add the number to the list of contacts (if it has not been added), delete the call from the list, and to call the number.



This list is held in temporary memory and will be lost if the device is reset. A number can be added to a name in the contacts list which is stored in permanent memory.

If there are missed calls then these may also be reported on the display in the idle state. In this case the up arrow can be used to access the list of missed calls.

Ending calls

At the end of a call there are two ways to disconnect.

If there is only a single call active this can be ended by hanging up the receiver. When using the speaker or headset the appropriate button should be pressed to terminate the call.

This disconnects all calls including any that are on hold.

If you only wish to terminate the current call then press the *C* button. Other calls that are on hold are not affected and will remain on hold. These can then be selected using the line buttons.

Volume

The volume can be adjusted during a call using the up / down keys. This can be useful as the volume for certain types of calls (SIP / mobile / PSTN) can vary.

During a call press the up or down key to show a new screen with the current volumes for the speaker and microphone. The up and down keys are then used to increase or decrease the volume. It is possible to switch between the microphone and speaker volumes using the *Mic* and *Spkr* soft keys.

Any changes are applied immediately for the current call but the previous settings will be used for future calls. An option is provided to store the current volumes for use in future calls.

Separate volumes are stored for the microphone and speaker. There are separate volume settings for the headset, handset and speakerphone. The volume adjustment is applied to the currently selected audio source for the call.

The volume setting screen vanishes after a few seconds of inactivity.

Making calls (using CTI via an attached PC)

This section describes how to use the Flexor 500 to make outgoing calls using Computer Telephony Integration (CTI) from an attached PC.

Using the call history page

You can dial a number from your PC using the Call History page. Follow the procedure below:

- ◆ Click on the Voice Connect application icon to display the Flexor 500 management web pages.
- ◆ Click on the Call History link. The Call History page is displayed showing the names and numbers of all recent incoming and outgoing calls.
- ◆ Click on the number you wish to call.
- ◆ The phone will dial the number and activate the speakerphone or headset.

Using the address book

You can dial a number from your PC using the Flexor 500 built-in Address book. Follow the procedure below:

- ◆ Click on the Voice Connect application icon to display the Flexor 500 management web pages.
- ◆ Click on the Address Book link. The Address Book page is displayed containing the names and numbers of your contacts.
- ◆ Click on the number you wish to call.
- ◆ The phone will dial the number and activate the speakerphone or headset.

Using Click-to-Dial

Click-to-Dial is a feature that enables you to dial any phone number or SIP URI that is on your Windows desktop. For example, you could have received a phone number in an email or found it on a web page.

To use the Click-to-dial feature, follow the procedure below:

- ◆ Highlight the phone number on the screen, and copy it to the clipboard (usually by pressing Ctrl-C or right-clicking and choosing Copy from the menu displayed).
- ◆ Right-click on the Voice Connect application icon in the bottom right of your Desktop.
- ◆ Choose the option Dial <number> from the menu displayed. (Where number is the number you have copied.)
- ◆ The phone will dial the number and activate the speakerphone or headset.

6 Using advanced phone features

One of the advantages of VoIP is that it offers advanced telephony features such as:

- ◆ Putting a call on hold
- ◆ Transferring calls
- ◆ Do not disturb
- ◆ Call divert
- ◆ Forward calls
- ◆ Conference calls
- ◆ Voice mail
- ◆ Call waiting

This chapter describes how to use the above features with your Flexor 500.

Putting a call on hold

The simplest way to put an active telephone call on hold is by using the hold button. The call can then be retrieved by pressing the hold button again.

There are two common situations where it is convenient to place a call on hold in a slightly different way:

- ◆ To answer a second incoming call that comes in during an existing call (known as Call waiting).
- ◆ To dial a second person in the middle of an existing call.

In both cases the current caller is placed on hold by selecting a different line using the line buttons.

In the first case a call is in progress on one line. A second call arrives on another line. The line button for this line flashes green to indicate the incoming call. Press the flashing line button to put the first call on hold and answer the new call.

The second case is where a call is in progress and you wish to call another person. Select another available line by pressing one of the line buttons with a solid green light. This puts the first call on hold and provides a dial tone to allow a second person to be dialled.

You can switch back to the person on hold, or swap between two callers using the line buttons. The line button is solid red for the current call and the line buttons for calls on hold are flashing red.

Transferring calls

It is possible to transfer an incoming call to another number. You can do this in two ways:

- ◆ **Attended transfer** – where you speak to the recipient of the transferred call before transferring the incoming call to them.
- ◆ **Blind transfer** – where you transfer a call immediately without speaking to the recipient of the call (the transferee).

Attended transfer

The attended call transfer is simple. The procedure to follow is:

1. The phone rings, and you pick-up to speak to the caller.
2. You decide that they need to be transferred to another person.
3. Press the *Xfer* soft key to start the transfer.
4. Enter the number for the person to whom you wish to transfer the call (the transferee) or use the *Addr* soft key to select this from the contacts list.
5. Press the *Cnslt* soft key to dial the number. At this point the caller is placed on hold. Wait for the transferee to answer the call.
6. After speaking to the transferee and confirming they wish to receive the transferred call press the *Xfer* soft key to connect the other two parties.

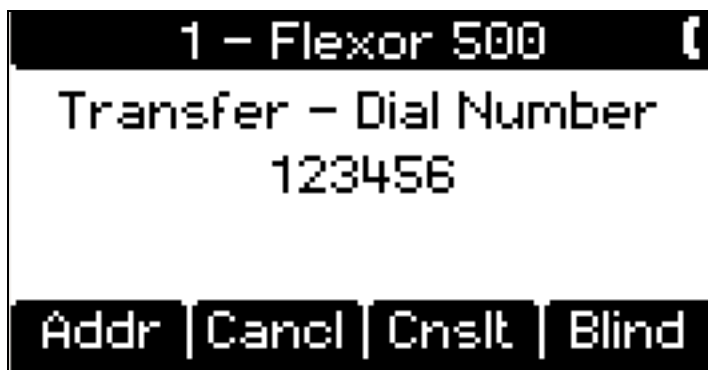

During an attended transfer there is an option to switch between the original call and the transferee using a *Swap* soft key. There is also a *Cancl* soft key to cancel the transfer and return to the caller.

Blind transfer

A blind transfer is easier than an attended transfer and works as follows:

1. The phone rings, and you pick-up to speak to the new caller.
2. You decide that they need to be transferred to another person.
3. Press the *Xfer* soft key to start the transfer.
4. Enter the number of the person to whom you wish to transfer the call (the transferee).
5. Press the *Blind* soft key to transfer the call automatically to the new number. You will hear a confirmation tone and can then hang up. The caller will hear the transferee's phone ringing.



Note

Note that for billing purposes you may be billed for the call to the transferred number, even though you do not have a conversation with them.

Do-not-disturb

The Do-not-disturb feature has a button with an associated LED to indicate the state.

The call features menu has a screen to set the *Do-not-disturb* feature. It has simple options to enable and disable the feature.

When the feature is enabled the LED is illuminated and any incoming calls are diverted to voicemail.

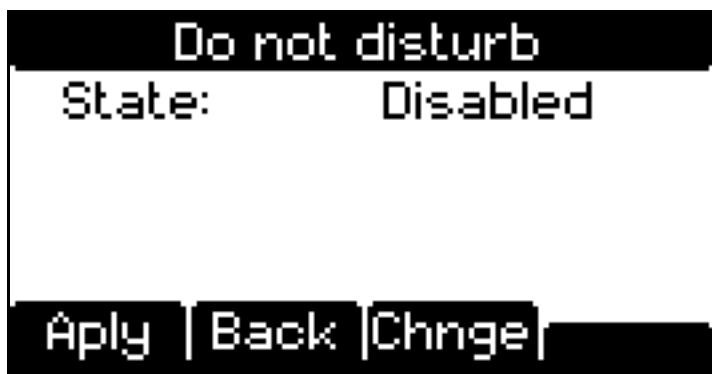

You can tell if *Do-not-disturb* is enabled by examining the LED indicator next to the button. This is illuminated when the feature is enabled.

Call divert

It is possible to divert all incoming calls to a different telephone extension or number.

This feature is accessed through the call features menu item.



The number for call divert can be selected from the contacts list using the *Addr* soft key or entered directly. When the settings are correct the *Apply* soft key is used to store the settings.



Note

The call divert feature does not work when Do-not-disturb is set. Calls can only be forwarded to voicemail or to a specified number.

Forward busy

If an incoming call arrives while the telephone is busy the new call can be automatically forwarded to another extension. It is also possible to forward calls to a voicemail account.

If there are multiple lines configured then any incoming calls will still be forwarded when there are active calls on any of the lines.

This feature is configured using the *Forward Busy* call feature option.

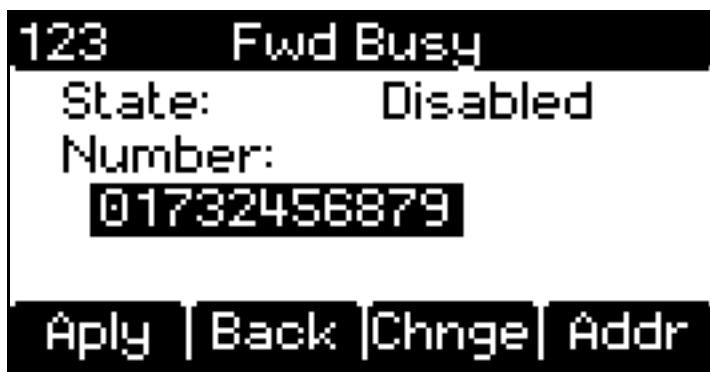

```
123      Fwd Busy
-----
State:      Disabled
Number:
  01732456879
-----
Aply | Back | Chnge | Addr
```

The settings for this are similar to those for the call divert but are only applied when the extension is busy.

Forward unanswered

This feature allows incoming calls to be diverted automatically to another extension after a delay if the call is not answered.

It is configured from the call features menu option.

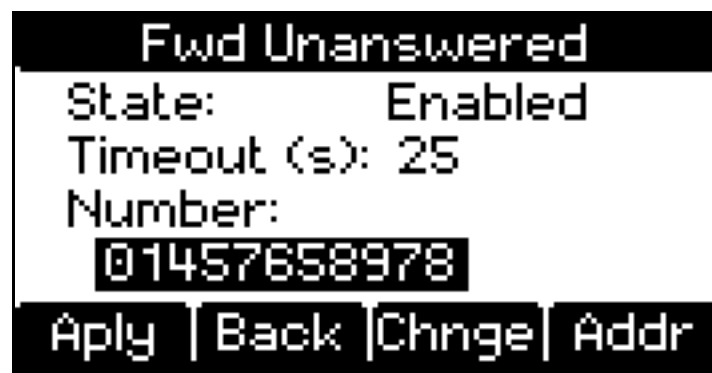

```
Fwd Unanswered
-----
State:      Enabled
Timeout (s): 25
Number:
  01457658978
-----
Aply | Back | Chnge | Addr
```

This is similar to the previous screens but with an extra field to enter a delay in seconds. The up / down keys are used to switch between the fields to enter.

The timeout has a maximum value of 60 seconds.

Reject anonymous calls

Another feature is the ability to reject calls where the caller does not identify their number. If the feature is enabled then these calls are rejected automatically when they arrive so that the telephone does not ring.

Conference calls (3 Way Calls)

This feature allows three people to take part simultaneously in a conference.

The feature is accessed during a standard call by pressing the *Confsoft* key to start a conference.

This provides an option to enter a number for the third party. Enter the number for the new call and press the *Confsoft* key to dial the number.

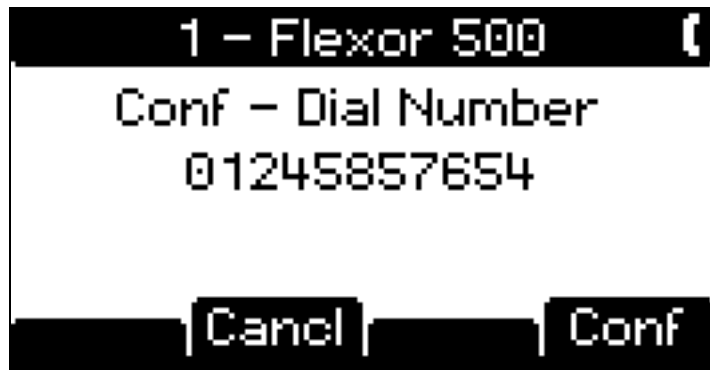

The original caller is placed on hold. When the third party in the conference answers the call you are connected to them with the original caller on hold.

The soft keys provide options to switch between the users during the conference. There are three possible states during the conference process:

- Three way conference.
- Talking to first person.
- Talking to second person.

In each of these states there are soft keys to switch to the other states.

The example below shows the screen during a three way conference. Options are provided to speak to the first person only and the second person only.

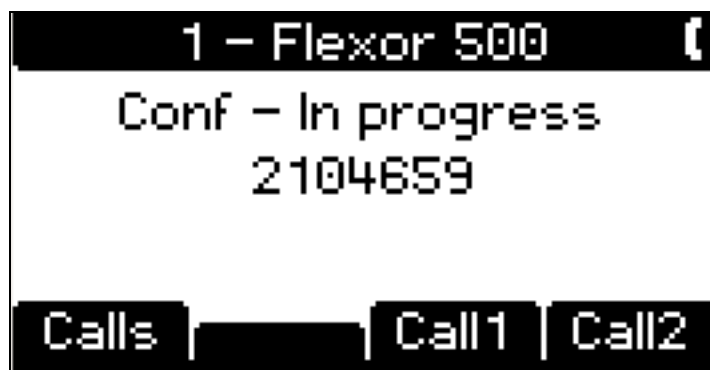

At the end of the conference press the *C* button to hang up all of the calls for the conference and end the process.

Voicemail

Most ITSP companies provide a voicemail facility so that callers can leave messages if the call is not answered.

The Flexor 500 shows when there are voicemail messages waiting using the MWI (Message Waiting Indicator) LED.

If there are new messages then a soft key in the default screen changes to show this. An extra line of text is shown below the current time with the number of new messages.

The voicemail can be accessed using this soft key or through the *Voicemail* option on the main menu.



The call option provides the ability to call the voicemail number to retrieve and manage the messages.

Call list

During a call it is possible to view the state of each of the four lines. This is accessed through the *Calls* soft key.

The list shows each line with the current state and the number where appropriate. If a match is found for the number in the contacts list then this is converted into a name.



In the first example there is an incoming call active on line 1. The number matched that for Laura Jones' home number. Line 2 has a call from an unrecognized mobile number that is currently on hold. Line 3 had an outgoing call to Andrew Wilson that has now ended. Line 4 is currently idle and does not have an associated number.

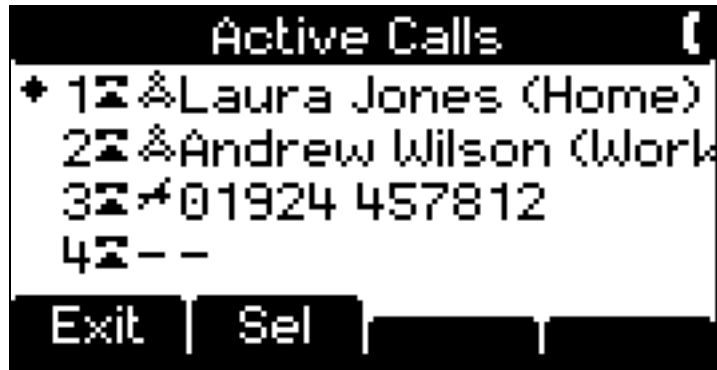

In this second example there is a conference with Laura Jones and Andrew Wilson. There was a missed call on line 3.

Call Waiting

When multiple lines are enabled several calls can be in progress simultaneously. An example is where a call is in progress and a second incoming call arrives. An indication of the incoming call is provided through the line buttons and it is possible to switch between the two calls.

There is an option on the call features menu to disable this feature. This could be useful if a call should be forwarded to another person rather than answered when the line is busy. Use the *Call Waiting* option on the call features menu to disable call waiting and then set the forward on busy option to allow calls to be forwarded to another number.

7 Managing the device from the menus

The menu system on the Flexor 500 provides a convenient way to adjust most of the settings. Certain aspects such as the SIP accounts and other advanced settings are only available through the web interface described on page 44. Many of these are configured by the service provider to the correct values and set to prevent a user altering them.

The menus can be navigated using the numbers to select an item or using the up and down keys to select an item.

The settings menu provides options to configure many user preferences and also some of the advanced settings that a user may wish to alter. It is divided into the following sections.

1. Network settings
2. Quality of Service
3. Region settings
4. Screen settings
5. Volume settings
6. Ringer options
7. SIP Account
8. Firmware
9. VLAN

In addition there is separate menu option for diagnostics. This is also described in this section.

Network settings

The network settings are usually configured automatically. In some cases there can be problems with the default settings. The network screen allows a user to select a different network mode and to manually assign an IP address.

Changes to the network settings will interfere with communications and should not be done while any calls are in progress.

The opening screen for the network configuration provides a list of the different modes for the configuration. There are two modes supported by the Flexor 500:

- ◆ **DHCP.** The Flexor 500 will request a dynamic network address from the network and use these settings. This is the default mode.
- ◆ **Manual.** The Flexor 500 enables you to enter all the required IP settings manually.

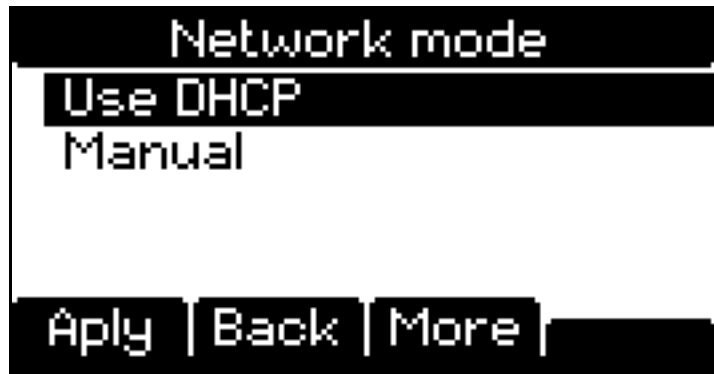

The *More* soft key provides access to a screen with details of the Internet settings. These show the current IP address, netmask, DNS server and gateway.

In DHCP mode these are allocated externally and cannot be changed. In manual mode the settings can be updated.

To enter these values manually scroll to the *Manual* menu item and press the *More* soft key. A screen is then provided as shown below to allow the IP configuration to be entered.



All of the settings for the IP address, netmask, DNS address and gateway must be entered. The numbers are entered using the digits and the up / down keys are used to switch between the entry fields.

When the settings have been entered press OK to return to the mode selection and then *Apply* to apply the new settings. This can take a few seconds.

Quality of Service

The QoS settings are advanced options intended to improve the call reliability. In most cases the default settings should be kept unless the ITSP suggests an alternative configuration.

If the Flexor 500 is connected between your LAN Ethernet switch and your PC, the Flexor 500 can shape traffic when a VoIP call is in progress. This enables the Flexor 500 to guarantee bandwidth for the VoIP call ensuring high quality calling. You should set the upstream bandwidth settings to match the upstream bandwidth of your broadband connection, to ensure that you do not artificially degrade your PCs networking performance.

The upstream bandwidth is measured in Kbps (kilo bits per second). The value is typically 256 for DSL and 100000 for 100Mb Ethernet.

The RTP and SIP DSCP are used by some service providers to give priority to voice traffic over other network traffic. The values are 6 bits in binary with a standard value of 001100.

The values should be entered as a series of binary digits using 1 and 0.



When the values have been set use the *Apply* soft key to store the new settings.

Region

The region settings cover the country code, time zone and time format. These may have been set by your ITSP.

A typical example of the settings is shown below.



The list of regions has most countries included. Use the *Time* soft key to view a list of time zones and the *12/24* soft key to choose between 12 and 24 hour time display.



The actual time is downloaded from an Internet time server and does not require manual setting.

Screen

The screen has a backlight feature to make it easier to see in certain lighting conditions. This is activated while the phone is being used and switches off after a period of inactivity.

The brightness of this backlight can be set for a personal preference. The value is shown as a percentage. In addition the backlight can be disabled if desired.

The brightness value is entered using the digits.

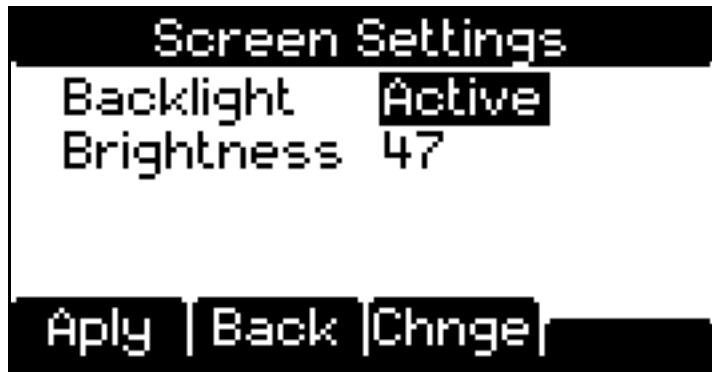

The settings must be applied before the change will be observed.

Volume

The volume screen provides a number of options related to the audio configuration.

The main settings provide options to set the microphone and speaker gain settings. These range between 1 (quiet) and 10 (loud).

These are the default volume settings used for future calls.



Note

The volume can be adjusted for a particular call while it is progress using the up / down keys. This is useful if a particular call is too quiet or loud.

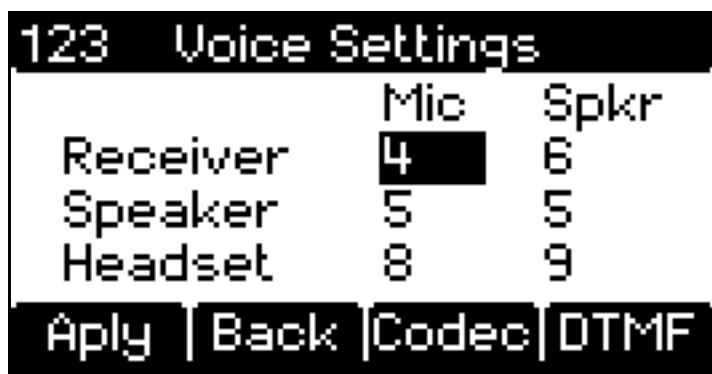

Separate volumes are provided for the handset (receiver), speaker and headset. Values are entered using the numeric keys, with the up / down keys used to navigate between the settings.

There are also options to set the audio codec and DTMF mode. These should not require adjusting for normal use.

If your device has been configured by a service provider then the DTMF option might not be available as this value has already been set correctly.

Codec selection

The codec screen provides an option to specify the permitted audio codecs and which one is preferred. These settings should not usually need changing and may have been locked by your ITSP.

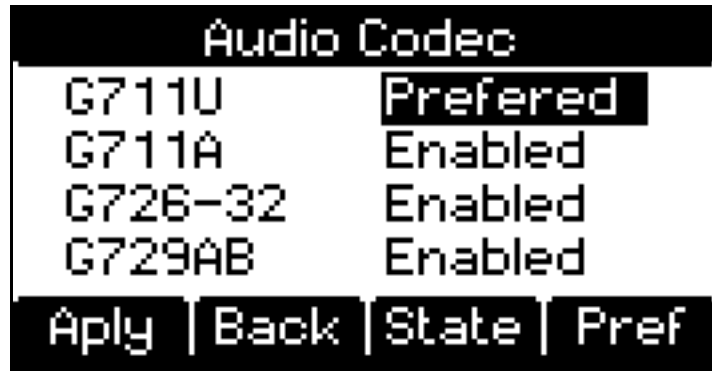

There are four supported codecs. The first three have a high bandwidth and the last has a low bandwidth. The *State* soft key enables or disables the use of a codec. The *Pref* soft key allows the selected codec to be set as the preferred one to use. A codec cannot be disabled while it is preferred.

DTMF

If your device has not been pre-configured by your service provider there may be an option to select how DTMF tones are sent. This setting should generally be left in the configuration recommended by the ITSP.

The options are **Inband** or **RFC2833 (RTP)** based DTMF support.

Ringer

There are three settings that relate to the ringer:

- Selection of ring tone.
- Control over volume of ringing.
- Ringing device can be set.

The screen below shows a typical example of the settings.



The item to change is selected using the up and down arrows. The *Chnge* soft key is used to alter the selected item. The *Apply* soft key is used to store the settings for future use.

The ring tones provides a list of the available ring tones. The *Play* option allows the selected ring tone to be heard.

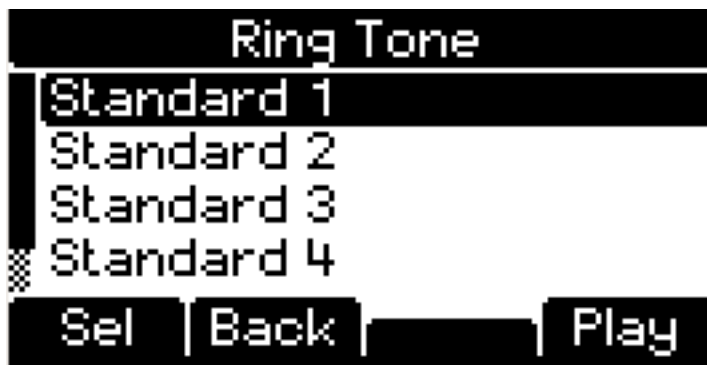

The ring device can be set to the speaker (default setting) or the headset.

If this is set to the headset then incoming calls will only ring in an attached headset and not through the speaker. The line light will still flash to indicate the call, but nothing will be heard. The selected device is also used as the default for making calls when a number is dialled with the phone still on the hook.

SIP accounts

The accounts are managed through the web pages as described on page 46.

The menus provide options to view the configured accounts and check the status and settings. There is a page with a list of the SIP accounts with an option to select an account. This leads to a detail screen as shown in the image below.

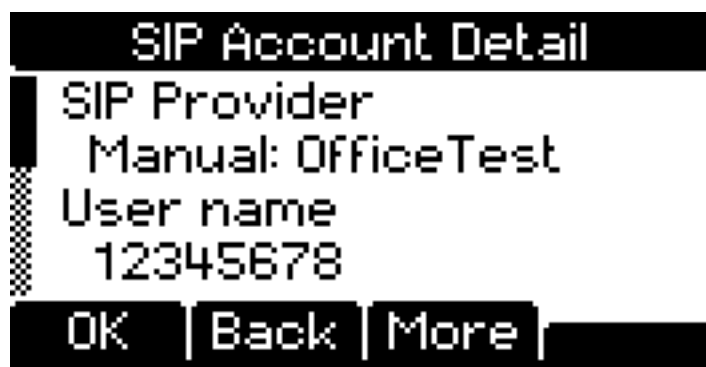

Additional information can also be obtained on the registrar and proxy configuration for each account. This may be useful for diagnosing errors.

Firmware

The screen displayed when the phone is inactive shows when new firmware is available. Although it is recommended that new firmware is installed when it becomes available to improve the reliability this is not always convenient.

The firmware menu option provides the option to check for new firmware and to see the current firmware version number. This may be required for technical support questions.

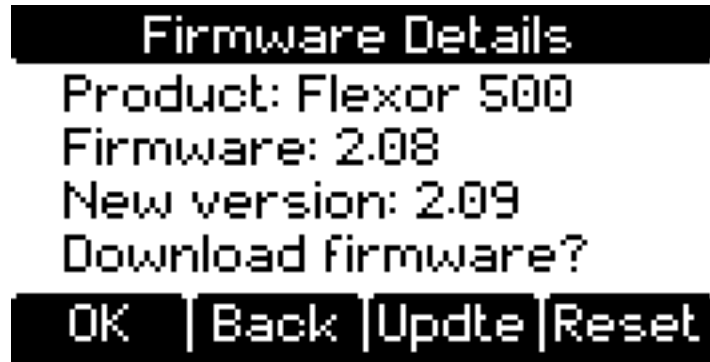

The firmware screen reports the current product name and firmware version. If there is a newer version of the firmware then an option is provided to download this.

This provides a confirmation screen before downloading and installing the new firmware.



The new firmware is downloaded from the Internet. A progress indicator is shown during this process.

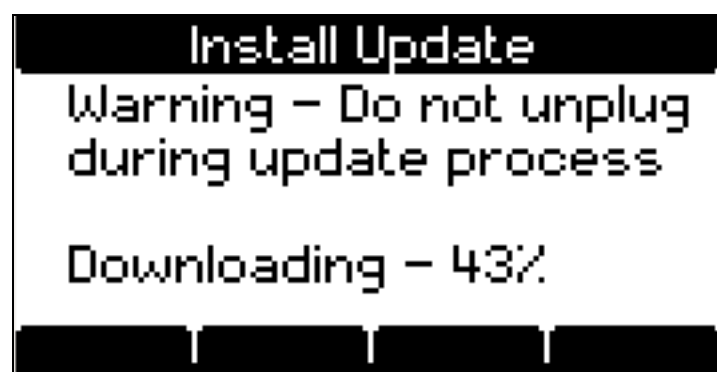

If an error is detected in the downloaded data then the download stops and an option is available to retry the download.



Warning

During the firmware update you must not remove power from the Flexor 500, or damage could occur. Do not remove the power cable. When in doubt, wait several minutes to let the unit go idle before removing the power.

Once the new firmware has been downloaded it is automatically installed. This process can take up to 30 seconds and must not be interrupted.

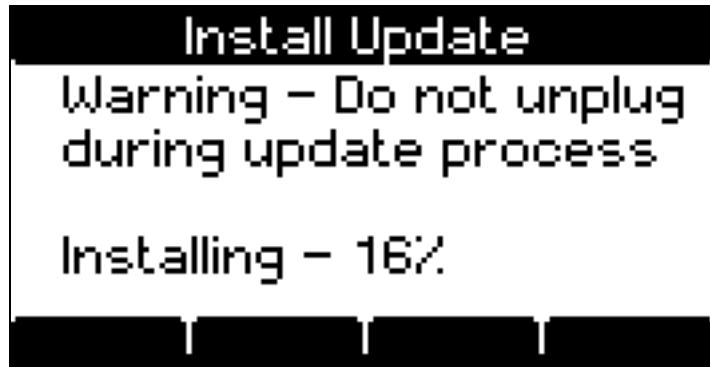

A screen is then shown with the option to restart the hardware using the new firmware or to continue without restarting.

Reset to defaults

An option is available from the firmware update screen to reset the settings to the factory defaults. This loses any modifications that have been made to the settings but is useful if the configuration has been set to something that doesn't work properly.

This does not delete addresses from the contacts list but it does delete all of the other configuration information. If the device was obtained from a service provider it should recover its settings on restarting, otherwise the account setting will have to be entered again.

If there are specific settings that you wish to keep then the web page configuration provides the ability to select what is reset and what is preserved.

VLAN

The Flexor 500 supports the IEEE 802.1Q standard for dividing a physical network into virtual networks or VLANs. If your Flexor 500 is attached to a network that has been partitioned in this way the settings can be configured to use this.

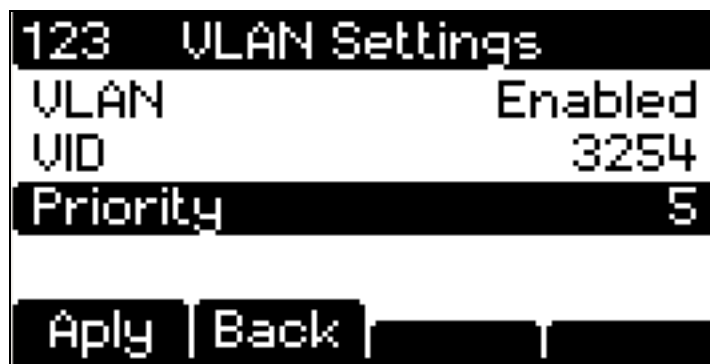

There are options to disable the feature (default) or to use it for the voice data only or for all data. The other settings are the VLAN identifier (0-4095) and the priority (0-7) that will be included in the Ethernet frames.

This feature should only be enabled if your LAN has been configured to use it. Incorrect settings can result in a loss of connection to the network.

Diagnostics

The diagnostics provide information that may be useful for technical support queries. It takes a few seconds to gather the diagnostics before the information is shown.



The information includes the product name and firmware version. The gateway and DNS addresses are also reported along with the status on the connection to them.

The *More* option shows further diagnostic information regarding the Internet connection. This includes:

- ◆ LAN and PC connections
- ◆ DHCP detailed settings
- ◆ NAT configuration

In addition there is a *Voice* diagnostics screen showing details of the SIP accounts. This can also be accessed from the *Settings* menu and provides a list of the accounts to allow the user to view the details of a particular account.

8 Managing the device using web pages

The Flexor 500 includes a series of Web pages that can be used to manage all aspects of the device. The web pages enable you to configure the device settings to meet the needs of your network. You can access the web pages through your web browser from any PC on the same local network as the Flexor 500.

This chapter contains the following sections:

- ◆ Accessing the Web pages
- ◆ Web pages overview
- ◆ Accounts
- ◆ Region
- ◆ Address Book
- ◆ Call History
- ◆ Call Management
- ◆ Flexor 500 Status

Accessing the Web pages

To access the Web pages, you need the following:

- ◆ A PC or laptop connected to the Ethernet port on the device or to an Ethernet port on the same local network.
- ◆ A web browser installed on the PC.

The procedure to follow to access the pages is different depending on the operating system of your PC.

From a Windows PC using VoiceConnect

To access the Web pages from a Microsoft Windows PC with the *Voice Connect* application installed, follow the procedure below:

1. From the PC, double-click on the *Voice Connect* icon in the *Quick launch* toolbar on the Windows Desktop.

A web browser will be launched displaying the Flexor 500 management web pages:

This is the first page displayed each time you access the Web pages.

From other PCs

To access the Web pages from a PC which is not running Windows, follow the procedure below:

1. From any of the LAN computers, launch your web browser, type the network address of the device in the web address (or location) box, and press [Enter] on your keyboard:

http://network-address

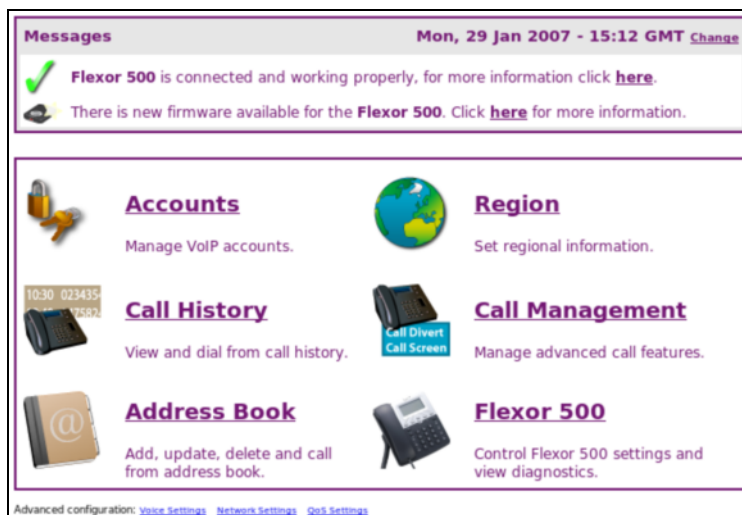

The web page address can be found from the *IP address* menu item on the device.

For more information on discovering the network address that needs to be entered for your device, refer to *Step 1a. Accessing the web pages without using VoiceConnect* on page 18.

2. The *Welcome* page is displayed.

Web pages overview

The web pages can be used to configure your device and to view information about the current settings of the device.

The Home page is the first page displayed each time you log in to the Web pages.

This page is divided into two areas:

- ◆ Messages area
- ◆ Configuration area

Messages area

The Messages area is the area where important status information is displayed. Examples of status messages appearing in this area are:

- ◆ Information on whether or not your VoIP connection is operational. If it is not working, a link is provided to help diagnose any problems.
- ◆ If a new software upgrade is available for your Flexor 500 a link will be provided to install it.
- ◆ Indication if you have any voice mail waiting.

Configuration area

The Configuration area contains a set of options which you can use to configure the Flexor 500.

The remaining sections of this guide describe the options contained in the Configuration area of the web page.

Managing accounts



Note

It is not possible to change your account details if your Flexor 500 was automatically configured by your Voice over IP operator.

In this section you can reconfigure your VoIP account settings. You may wish to do this for several reasons:

- ◆ To correct a mistake in your original configuration
- ◆ To switch to an alternative VoIP account
- ◆ To update your account name but leave the other account settings unchanged.

This option is not available if your ITSP has configured the phone automatically.

To view or modify your VoIP account settings, click on the **Accounts** button on the Welcome page. The Accounts window is displayed:

Refer to the following section to manage your accounts.

Modifying VoIP accounts

To modify your current VoIP accounts, follow the procedure below:

- ◆ To select a new VoIP provider, select the new provider from the drop-down list box. The Account Settings fields are automatically updated with the details of the selected provider.
- ◆ Edit the fields individually as required. It is possible to change the Your name field which is the name used by the device for all calls you make. All other settings should not normally need to be changed unless you are specifically instructed to do so by your VoIP provider.
- ◆ Click on Update.

The home page is displayed containing the following message in the Configuration area:

1. Click on **here** to reboot the device. A final message is displayed asking you to confirm that you wish to reboot the device:

2. Click on **Reboot** to reboot the device. The web browser is closed and the device is rebooted.

The new VoIP account settings will now be used for all future calls.

Create a new VoIP account

To create a new VoIP account:

Follow the procedure in the previous section to display the **Accounts** page.

To create a new account you can either:

- ◆ Use the configuration wizard.
- ◆ Enter the settings manually.

It is recommended that you use the Configuration wizard to create a new account.

To use the Configuration wizard, click on the [here](#) link on the Accounts page. The following page is displayed:

Refer to *Step 4. Configure your VoIP account on page 19* for the procedure to follow to create your account using the Configuration wizard.

To enter the new account settings manually, click on the **Manual Setting** link. The following window is displayed:

Enter the details for your new account in this window:

- ◆ Enter a name for the account followed by all the details of the account. (Your VoIP account provider should have provided you with all the details shown on this page.)

- ◆ Click on Save Settings when you have added all the details for the new account.
- ◆ The Accounts page will be displayed and from the drop-down list box a new entry will have been created, prefixed with Manual to identify this account as one that has been manually entered.

Setting a region

The Region web page enables you to configure the region where you are using your device and the time zone for that region. Setting the time zone ensures that your device is always using the correct time.

To configure region information, click on the **Region** link in the Home page. The **Regional Settings** window is displayed:

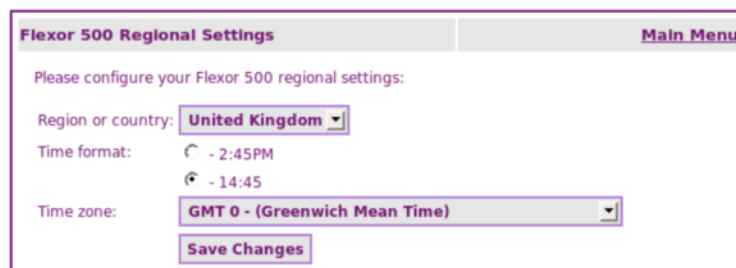

The screenshot shows the 'Flexor 500 Regional Settings' web page. At the top left is the title 'Flexor 500 Regional Settings' and at the top right is a link for 'Main Menu'. Below the title, it says 'Please configure your Flexor 500 regional settings:'. There are three main settings: 'Region or country:' with a dropdown menu currently set to 'United Kingdom'; 'Time format:' with two radio button options, '- 2:45PM' and '- 14:45'; and 'Time zone:' with a dropdown menu currently set to 'GMT 0 - (Greenwich Mean Time)'. At the bottom of the form is a 'Save Changes' button.

From this page you can set the following information:

- ◆ The Region or Country where you are using the device
- ◆ The Time format for displaying the time on subsequent web pages. The time can be displayed in 12-hour or 24-hour format.
- ◆ Time zone for the region where you are using the device.

Setting the region

The region where you are using the device is setup when you first configure the device and so you should normally not need to change this setting. (See *Step 3. Select your country* on page 19.)

To set the region or country where you are using the device, follow the procedure below:

- ◆ Choose the country from the **Region or country** drop-down list box.
- ◆ Click on **Save Changes**.
- ◆ The Home page is displayed.

The call progress tones are also updated to use the tones specific to the region that has been selected.

Setting the time format

All call information displayed by the web pages contains details about the time of the call. You can configure the display of this time to be shown in 12-hour or 24-hour format.

The time format is also used on the Flexor 500 display for the current time.

To set the time format, follow the procedure below:

- ◆ Click on the radio button alongside the time format you require in the **Time format** field.
- ◆ Click on **Save Changes**.

The Home page is displayed. The messages window will show the new time format in the top-right corner of the window.

Setting the time zone

To set the time zone for your region, follow the procedure below:

- ◆ Choose the time zone from the **Time zone** drop-down list box.
- ◆ Click on **Save Changes**.

The Home page is displayed. The Messages window will show the new time zone displayed in the top-right corner of the window, alongside the time.

Viewing the call history

In the call history subsection of the Flexor 500 web pages you can view recently received calls, and recently dialled numbers. Viewing recently received calls is useful if you have been away from your phone for a while and wish to check if you have missed any calls.

To view the call history for your device, click on **Call History** from the home page. The **Call History** window is displayed:

Flexor 500 Call History		Main Menu	
Call Summary			
	Party	Time	Duration
Received	Andrew Wilson (Home)	Today at 16:11 8 s	Add
No answer	2104652	Today at 16:16 -	Add
Called	01223307125	Today at 16:45 28 s	Add

The window displays calls that you have made and calls that you have received. The call history is cleared following a reboot of the device, so the history contains a record of all calls made and received since the last time that the device was rebooted.

The display shows the number if it is found in your address book or the number otherwise.

The example above shows one call that was received, one that was made but unanswered and a completed call. If there are any missed calls these are also listed.

For both received and dialled calls you can dial the number to return the call by clicking the number on the web page. For more information, refer to *Making and receiving phone calls on page 22*.

Using the address book

Your Flexor 500 has a built-in address book, and this is accessed through the **Address book** link from the Home page:

Address Book	Search	Add	Main Menu
First Name	Last Name		
<input type="text"/>	<input type="text"/>	<input type="button" value="Search"/>	
Name	Home	Work	Mobile
Brian Hawkins	01234567890	01324987654	07891234567 Change Delete
Charles Jones	01234654987	2104659	Change Delete

The address book has several purposes:

- ◆ To look up the name of incoming calls, and present the name of the caller instead of their number on the phone display and the on screen pop-up.
- ◆ To speed dial numbers from the address book.
- ◆ To dial SIP URIs (addresses).

This section describes how to use the address book:

- ◆ *Adding entries to the address book on page 50.*
- ◆ *Editing the address book on page 51.*
- ◆ *Deleting entries from the Address book on page 51.*

Adding entries to the address book

The easiest way to add entries to the address book for all your contacts is to import entries from your Microsoft Outlook contacts on your PC.

To manually add entries to the address book, follow the procedure below:

- ◆ Click on **Add** in the Address book window.

The following window is displayed:

Address Book	Search	Add	Main Menu
Name	Home	Work	Mobile
<input type="text"/>	<input type="text"/>	<input type="text"/>	<input type="text"/>
<input type="button" value="Add"/>			

- ◆ Enter the full name of the contact in the **Name** field. This includes first name *and* second name.
- ◆ Enter the phone numbers of the contact in the **Home**, **Work** and **Mobile** fields. (You do not have to enter a number in every field.)
- ◆ Click on **Add**.

The new contact (e.g. Fred Smith) is added to the address book:

Address Book	Search	Add	Main Menu
First Name	Last Name		
<input type="text"/>	<input type="text"/>	<input type="button" value="Search"/>	
Name	Home	Work	Mobile
Fred Smith	01223123456	01223456789	0123456789 Change Delete

If this contact has any entries in the Call History log, then the log will be automatically updated to show the name of the contact alongside the call entry.

In addition, any future calls received from any of the numbers associated with this caller will be displayed on your PC using the name of the caller rather than their number. See *Using the call history page on page 48*

Once a name and number are in the address book you can also use your PC to dial the number in a variety of ways, see *Making calls (using CTI via an attached PC)* on page 25 for further details.

Editing the address book

To edit the details of a contact in the address book, follow the procedure below:

- ◆ Click on the **Change** link in the Address book window alongside the contact you wish to edit.

The following window is displayed containing the details of the contact:

Address Book	Search	Update	Main Menu
Name	Home	Work	Mobile
Fred Smith	01223123456	01223456789	0123456789
Update			

- ◆ Edit the phone details of the contact.
- ◆ Only the phone numbers of the contact can be edited.
- ◆ If you need to change the name of the contact, you will have to delete the contact. See *Deleting entries from the Address book* on page 51.
- ◆ Click on **Update**.
- ◆ The updated details are displayed in the Address book window.

Deleting entries from the Address book

To delete a contact from the Address book, follow the procedure below:

- ◆ Click on the **Delete** link in the Address book window alongside the contact you wish to delete.

The following window is displayed asking you to confirm that you wish to delete the contact:

Address Book	Search	Delete	Main Menu
Name	Home	Work	Mobile
Fred Smith	01223123456	01223456789	0123456789
Confirm Delete			

- ◆ Click on **Confirm Delete** to delete the contact from the Address book.
- ◆ The Address book window is displayed with the deleted contact removed from the list of contacts.

Call management

The call management section of the Flexor 500 web pages allow you to configure what happens to incoming calls. This configuration is closely tied to the buttons on the Flexor 500 as described in *Buttons and LED indicators* on page 10.

The Call Management page is shown below:

A number of different actions are possible for an incoming call:

- ◆ Ring the phone as normal; eventually ringing-out to voicemail if the call is not answered in time.
- ◆ Allow the phone to ring for a specified time and then divert to a specified number.
- ◆ Divert all calls to another number.
- ◆ Divert all calls to voicemail.
- ◆ Divert calls to another number if the phone is busy.



Note

Note that only one of voicemail and divert can be used at once.

By default, none of these above actions are enabled on the device. An incoming call will either stay ringing or divert to any voicemail feature you have setup on your phone.

In addition calls can be diverted to a particular number when the line is busy rather than being directed to the voicemail.

The following sections describe how to configure the Flexor 500 to enable the actions described above for incoming calls.

Setting up call divert

To enable call diversion for all incoming calls enter an number from the Call Management web page in the **Call Divert Number** field. Click on **Save Settings** to store the new setting and return to the home page.

The call diversion is then activated using the *Do Not Disturb* button from the device. If there is no number set then the *Do Not Disturb* button causes all incoming calls to be forwarded to the SIP account voicemail.

Now if a call is received and the Do Not Disturb function is set, the Flexor 500 will divert the call to the specified number. Note that your VoIP account will be billed for the diverted part of the call.

Setting up voicemail

The voicemail is also enabled using the *Do Not Disturb* button. This is only used when there is no divert number set.

Your ITSP provider will have provided you with details of how to listen to and edit your voicemail messages. This is typically displayed via a web page. Refer to your ITSP for more information.

Setting divert on busy

This feature allows incoming calls to be redirected to another number if the telephone is busy.

This requires a number to be entered in the **Divert on busy to** field and the feature to be enabled from the checkbox.

Note that call waiting notification will not work when this is enabled.

Setting divert after timeout

This causes incoming calls to be diverted to be forwarded to another number if they are not answered within a specified time. The number and a delay in seconds are entered from the web page.

Reject anonymous calls

Calls can be rejected automatically when the caller identification is not provided with the call. This can be useful to reject automated calls from call centres.

Flexor 500 Status

The Flexor 500 Status web page allows you to control various settings of the device and to view diagnostic information about the device.

The Flexor 500 web page is shown below:



Messages Tue, 06 Feb 2007 - 15:52 GMT [Change](#)

 **Flexor 500** is connected and working properly, for more information click [here](#).

Flexor 500 Status	Diagnostics	Reset Settings	Main Menu
Please click here to check for firmware updates.			
Flexor 500 is connected to the Internet and ready for use.			
The current service provider is Manual: OfficeTest .			
The region is set to United Kingdom .			
For additional diagnostics click here or to reboot click here .			
Model: Flexor 500 Firmware: 2.04			

The page provides a summary of the current status of the device, including:

- ◆ Internet connection status.
- ◆ Current service provider.
- ◆ Region setting.
- ◆ Model and firmware revision number of the device.

From this page you can also perform the following actions:

- ◆ Check for firmware updates
- ◆ Perform diagnostic checks
- ◆ Reboot the device
- ◆ Reset the device

These actions are described in Troubleshooting *on page 62*.

9 Advanced configuration options

This section details the following advanced configuration options:

- ◆ Voice Volume Settings
- ◆ CODEC Preference
- ◆ DTMF Mode
- ◆ QoS Settings
- ◆ Network Settings

Changing these options may affect your network connectivity, internet telephony or voice call quality.

Voice settings

Volume settings, CODEC preference and DTMF Mode can be set from the Voice Settings menu. This menu is accessed by clicking on the **Voice Settings** link on the home page. The diagram below shows the Voice Settings menu:

Flexor 500 Voice Settings [Main Menu](#)

Volume Settings

	Microphone			Speaker		
Receiver	-	5	+	-	5	+
Speaker	-	5	+	-	5	+
Headset	-	5	+	-	5	+

Valid values are 1-10, 5 is the default

Ringer Volume **Normal** ▾

Voice CODEC Selection

CODEC Preference: **G.711U** ▾

CODECs Enabled:

High bandwidth	G.711U	<input checked="" type="checkbox"/>
	G.711A	<input checked="" type="checkbox"/>
	G.726-32	<input checked="" type="checkbox"/>
Low bandwidth	G.729AB	<input checked="" type="checkbox"/>

DTMF Mode

Inband

RFC2833 (RTP)

Save Settings

Volume settings

It is possible to change the microphone and speaker volume settings in each of 3 cases:

- ◆ Receiver
- ◆ Speaker phone
- ◆ Headset.

The values can be changed using the + and – buttons or by entering a number between 1 and 10 in the appropriate volume setting box.

There is also an option to set the ringer volume. This has three values – low, normal, high. The values can be selected using the drop down list.

Settings are applied and saved using the **Save Settings** button.

Voice CODEC selection

It is possible to change the preferred voice codec; this is the codec that will be used in preference for any VoIP call, and to change the codecs that are enabled on the Flexor 500. Settings can be changed as follows:

- ◆ Codecs can be enabled and disabled by checking and unchecking the check boxes next to each codec name in the Voice codec Selection area.
- ◆ The preferred codec can be selected from the **Codec Preference** drop down list.
- ◆ Changes can be saved by clicking **Save Settings**.

DTMF mode

These settings may have been fixed by your ITSP and will not be shown in this case.

Change settings as follows:

- ◆ Select either **Inband** or **RFC2833 (RTP)** based DTMF support by clicking on the appropriate radio button in the DTMF Mode section.
- ◆ Changes can be saved by clicking **Save Settings**.

QoS (Quality of Service) settings

QoS (Quality of Service) settings can be set from the QoS Settings menu. This menu is accessed by clicking on the **QoS Settings** link on the home page. The diagram below shows the QoS Settings menu:

The screenshot shows the 'Flexor 500 QoS Settings' web interface. At the top left is the title 'Flexor 500 QoS Settings' and at the top right is a 'Main Menu' link. Below the title, there is a label 'Upstream bandwidth:' followed by a text input field containing '256' and a note '(256 normal for ADSL, 100000 100Mbps Ethernet)'. Underneath, there is a section for 'Advanced QoS settings' containing two rows: 'RTP DSCP:' with a text input field containing '001100', and 'SIP DSCP:' with a text input field containing '001100'. At the bottom of the form is a 'Save Settings' button.

Upstream bandwidth shaping

When the Flexor 500 is connected between your LAN Ethernet switch and your PC, the Flexor 500 can shape traffic when a VoIP call is in progress. This enables the Flexor 500 to guarantee bandwidth for the VoIP call ensuring high quality calling. You should set the upstream bandwidth settings to match the upstream bandwidth of your broadband connection, to ensure that you do not artificially degrade your PCs networking performance.

To change the settings:

- ◆ Enter the **Upstream bandwidth** in Kbps (kilo bits per second). Note 256 Kbps is typical for DSL.
- ◆ Changes can be saved by clicking **Save Settings**.

RTP and SIP DSCP

To change the DSCP used for SIP and RTP:

- ◆ Enter the new DSCP into the RTP and SIP fields.
- ◆ Changes can be saved by clicking **Save Settings**.

Network settings

The Flexor 500 network settings menu can be accessed by clicking the **Network Settings** link from the Flexor 500 home page. There are two modes supported by the Flexor 500:

- ◆ **DHCP**. The Flexor 500 will use DHCP to dynamically allocate an address. This is the default setting.
- ◆ **Manual**. The Flexor 500 enables you to enter all the required IP settings manually.

The network settings can also be controlled from the device menus which can be useful if there are networking errors and the web pages are not available.

The network settings menu is shown below and includes information on the current network settings:

Flexor 500 Network Settings	Main Menu
Configuration Mode	
<input checked="" type="radio"/> - DHCP	
<input type="radio"/> - Manual	
Current Network Settings	
Configuration Mode: DHCP	
IP Address: 10.0.0.210	
Network Mask: 255.255.255.0	
Gateway: 10.0.0.2	
DNS: 10.0.0.2	
Save Settings	

In order to select **DHCP** or **Manual**:

- ◆ Select the appropriate radio button option.
- ◆ Changes can be saved by clicking **Save Settings**.

Once you have saved settings the web browser will display a page describing the network change that has been made and offers guidance on how to continue managing the Flexor 500 via the web pages. An example for the case when **DHCP** has been selected is shown below:

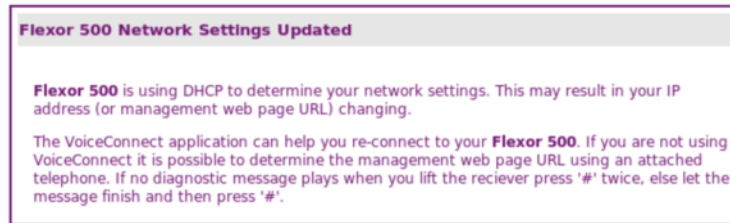

In order to select **Manual** settings:

- ◆ Click on the **Manual** radio button option. An additional set of configuration options will appear:

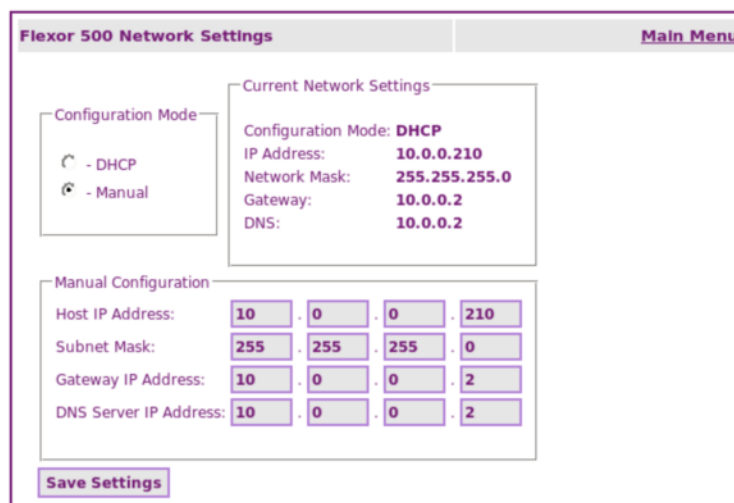

- ◆ Enter the network IP configuration into the appropriate fields.
- ◆ Changes can be saved by clicking **Save Settings**.
- ◆ Once you have clicked **Save Settings** you will be shown a page which will enable you to navigate to the embedded web pages again:

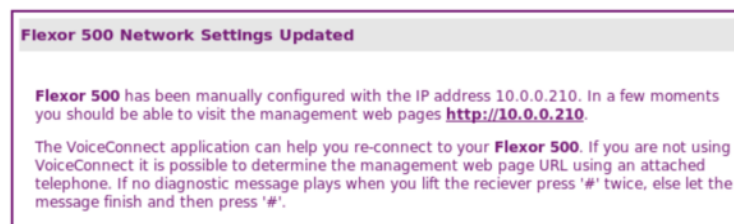

- ◆ Click on the <http://network-address> link to return to the management web pages.

10 LAN Provisioning

Introduction

LAN Provisioning allows centralised server based configuration for a group of phones. Typically this might be used in an office-like environment for easy configuration and maintenance of the company phone system.

The Flexor 500 is told to enter LAN Provisioning mode by a DHCP server as part of its initial configuration when acquiring IP address settings.

DHCP server configuration

To aid the DHCP server in processing requests, each CamrivoX device will include DHCP Option 60 (Vendor Class Identifier) in any requests they issue. The value for the Flexor 500 is “CamrivoX fl500”. The DHCP server may not need to use the information – it is merely provided by the device for the server’s convenience.

To enable LAN Provisioning, the DHCP server must be configured to issue each CamrivoX telephone with DHCP Option 67 (Boot file name).

The value supplied should be a URL that the device can fetch to retrieve its configuration file. The URL can use TFTP or HTTP. Additionally, the hostname part of the URL is optional, and if omitted will be automatically completed with the address of the DHCP server. Furthermore, the optional string %MAC_ADDRESS will be expanded by the CamrivoX device to the MAC address of the device before the URL is fetched.

Example boot file names are given below, with their automatically completed canonical forms also shown. In this example, the MAC address of the device is 00:17:A2:01:02:03, and the IP address of the DHCP server is 192.168.0.1. In a real network, for the example to make sense in the cases where the IP address of the server is auto-completed, it is assumed the DHCP server would also be running the TFTP/HTTP server:

Boot file name	Canonical Form (URL that is fetched)
http://my.host/path/unit_%MAC_ADDRESS.txt	http://my.host/path/unit_0017A2010203.txt
http://path/unit_%MAC_ADDRESS.txt	http://192.168.0.1/path/unit_0017A2010203.txt
tftp://my.host/path/unit_%MAC_ADDRESS.txt	tftp://my.host/path/unit_0017A2010203.txt
/path/unit_%MAC_ADDRESS.txt	tftp://192.168.0.1/path/unit_0017A2010203.txt
unit_%MAC_ADDRESS.txt	tftp://192.168.0.1/unit_0017A2010203.txt
my.host/unit_%MAC_ADDRESS.txt	tftp://192.168.0.1/my.host/unit_0017A2010203.txt

Note that the final example is given to demonstrate a common error made in specifying the URL. “my.host” is interpreted as the path and not the name of the host.

On a Linux DHCP server the following configuration would be typical:

```
host My_Flexor500 {
    option domain-name-servers 192.168.0.1;
    option routers 192.168.0.1;
    hardware ethernet 00:17:A2:01:02:03;
    fixed-address 192.168.0.10;
    filename "unit_%MAC_ADDRESS.txt";
}
```

Configuration File specification

The TFTP or HTTP server should provide a single configuration file for each device requiring configuration. Below is an example file, followed by explanations of each directive:

%SECTION PROVIDER

```
"Version", "1"
"Name", "Office Phone System"
"Registrar", "sip.server"
"Domain", "sip.server"
"Proxy", "proxy.server:5082"
"Stun", ""
"Dtmf", "rfc2833"
"SIPMap", "(**x.T|x.T|6xx|00x.T|0[123456789]xxxxxxxx)"
"MapSDP", "0"
"Voicemail", "*1"
"Codec", "PCMU,PCMA,G726-32,G729"
"Country", "United Kingdom"
"StunSym", "1"
"End"
```

%SECTION USER

```
"Version", "1"
"Username", "2002542"
"Password", "1234"
"Name", "Test"
"Auth-Name", ""
"End"
```

Section – Provider

Field name	Mandatory or Optional	Description
Version	M	Must be set to 1.
Name	M	Friendly name of service, to be display on screen.
Registrar	M	Hostname or IP address of SIP registrar.
Domain	M	SIP Domain.
Proxy	O	Hostname or IP address of SIP proxy.
Stun	O	Hostname or IP address of STUN server. Not required if proxy is NAT aware.
DTMF	M	Set to "inband" or "rfc2833", indicating how DTMF tones should be transmitted from the phone.
SIPMap	M	This field is like a regular expression, and provides the dial plan for the phone. The syntax

		is as follows:														
		<table border="1"> <thead> <tr> <th>Characters</th> <th>Description</th> </tr> </thead> <tbody> <tr> <td>0, 1, 2, 3, 4, 5, 6, 7, 8, 9, #, *</td> <td>Digits as dialled on phone.</td> </tr> <tr> <td>x</td> <td>Any digit.</td> </tr> <tr> <td>. (full stop)</td> <td>Repeat previous expression (like * in Unix regular expressions).</td> </tr> <tr> <td>T</td> <td>Timeout – collect extra digits, timing-out after 4 seconds.</td> </tr> <tr> <td> </td> <td>OR – separator between expressions.</td> </tr> <tr> <td>()</td> <td>Brackets are used to group characters into a single expression.</td> </tr> </tbody> </table>	Characters	Description	0, 1, 2, 3, 4, 5, 6, 7, 8, 9, #, *	Digits as dialled on phone.	x	Any digit.	. (full stop)	Repeat previous expression (like * in Unix regular expressions).	T	Timeout – collect extra digits, timing-out after 4 seconds.		OR – separator between expressions.	()	Brackets are used to group characters into a single expression.
Characters	Description															
0, 1, 2, 3, 4, 5, 6, 7, 8, 9, #, *	Digits as dialled on phone.															
x	Any digit.															
. (full stop)	Repeat previous expression (like * in Unix regular expressions).															
T	Timeout – collect extra digits, timing-out after 4 seconds.															
	OR – separator between expressions.															
()	Brackets are used to group characters into a single expression.															
MapSDP	M	Boolean: 0 or 1. Use STUN to map ports in SDP (or not).														
Voicemail	M	Telephone number for voicemail.														
Codec	M	List of codecs to support, in order of preference.														
Country	M	Name of country.														
StunSym	M	Boolean: 0 or 1. Disables STUN when symmetric NAT detected.														
End	M	Each section must be terminated with “End”.														

Section – User

Field name	Mandatory or Optional	Description
Username	M	SIP user name.
Password	M	SIP password.
Name	M	Friendly name of user.
Auth-Name	O	User name used for SIP Authentication.
End	M	Each section must be terminated with “End”.

LAN Provisioning error codes

If something goes wrong during LAN provisioning, an error code will be displayed on the screen of the phone. The codes are explained below:

Error code	Description
D1	Problem parsing the boot file name issued by the DHCP server – check the file name for errors.
H1	HTTP GET failed when retrieving configuration file from server – check the boot file name for errors, and that the HTTP server is correctly serving the file.
H2	Response from HTTP server was not HTTP.
H3	HTTP server did not reply with 200 OK.
H4	Temporary problem storing configuration file in RAM.
T1	Failed to connect to TFTP server.
T2	TFTP GET failed while retrieving configuration file – check the boot file name for errors, and that the TFTP server is correctly serving the file.
F1, F2, F3, F4, F6	Temporary problem storing configuration file in RAM.
F5	Unknown SECTION directive in configuration file.

11 Troubleshooting

This chapter provides information to help you to diagnose any problems you may be having with your Flexor 500 device.

Resetting to factory defaults

It is possible to restore your Flexor 500 back to its factory default state.



Warning

This action can potentially erase all your settings and address book entries, so you should choose to keep all the settings and the address book entries that you want to save when asked to do so.

To reset your Flexor 500 to its factory default state, follow the procedure below:

- ◆ Select the **Flexor 500** option from the main management web page.
- ◆ Select **Reset Settings** in the top of the window.

The following window is displayed:

Flexor 500 Status	Diagnostics	Reset Settings	Main Menu
Please select settings to keep:			
<input type="checkbox"/> Keep account settings			
<input type="checkbox"/> Keep regional settings			
<input type="checkbox"/> Keep call management options			
<input type="checkbox"/> Keep all address book entries			
<input type="checkbox"/> Keep all advanced settings			
Note - resetting the Flexor 500 to factory defaults will lose all configuration, settings and address book entries, unless you 'keep' selected settings.			
Clicking the button below will close the browser window and then reset and restart the Flexor 500 .			
Reset and Restart			

- ◆ To reset the device to its factory default state, click on **Reset and Restart**.
- ◆ If you would like to keep some of the settings you have configured for the device, click on the check box alongside the setting that you want to preserve and then click on **Reset and Restart**.
- ◆ The web browser window is closed and the device is reset.



Note

If you can't access the web pages, it is also possible to reset the device using the menu system. See [Reset to defaults on page 42](#) for full details.

If there are further problems then it is possible to delete all of the settings by restarting the device while holding down the 0 button when the device

first starts up. This deletes all settings including any SIP account details and address book entries.

Upgrading the firmware



Warning

During the firmware update you must not remove power from the Flexor 500, or damage could occur. Use the menu or web page options to reboot the device. Do not remove the power cable. When in doubt, wait several minutes to let the unit go idle before removing the power.

From time to time new firmware upgrades will become available for your Flexor 500 which can be downloaded over the Internet and then installed on the device.

The screen will indicate when there is new firmware if it is working correctly and there is no call activity. See Firmware on page 40 for details of installing firmware updates directly from the device.

From the web pages you can check if there is a firmware update available and if there is an update you can download and install the firmware on the device.

Alternatively you may receive a new firmware notification in the messages area, as shown below:

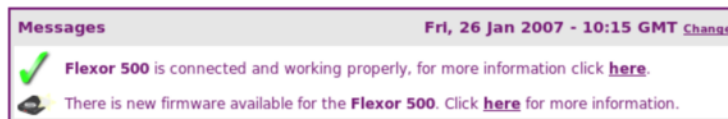

In this case click [here](#) in the sentence *Click [here](#) for more information* and proceed straight to [step 2](#).

To manually check for firmware updates, follow the procedure below:

Step 1 – Check for firmware updates

- ◆ Select the Flexor 500 option from the main management web page.
- ◆ Click on the **here** link on the 'Please click [here](#) to check for firmware updates' line on the web page.
- ◆ If the firmware is up to date the following window is displayed:

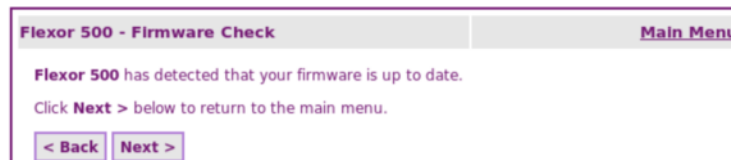

- ◆ Click **Next >** to return to the main menu.
- ◆ If the firmware needs updating the following window is displayed:

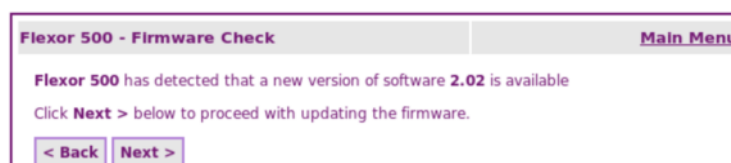

- ◆ Click **Next >** and proceed to [step 2](#).

Step 2 – Confirm update to new firmware

A window will be displayed showing the new version of firmware that is available:

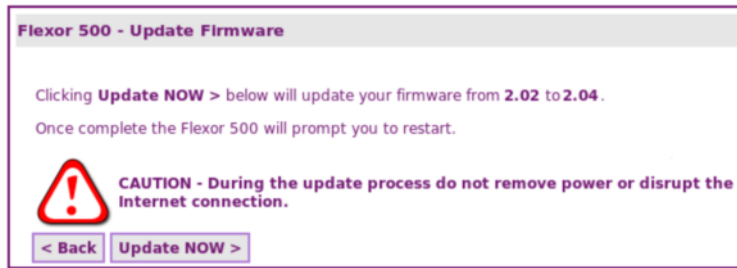

Click **Update NOW >** to continue with the firmware update process.

Step 3 – Firmware update in progress



Warning

During the firmware update do not remove the power or disrupt the Internet connection to the Flexor 500.

A window will first show the progress of the firmware download from the Internet:

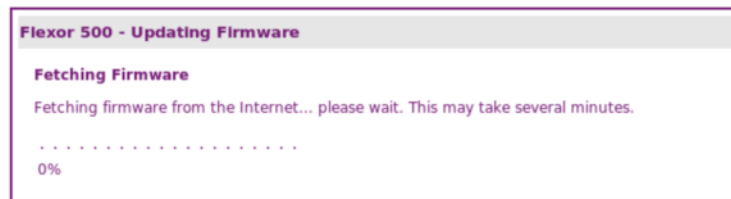

It will then show the progress of the firmware update on the Flexor 500:

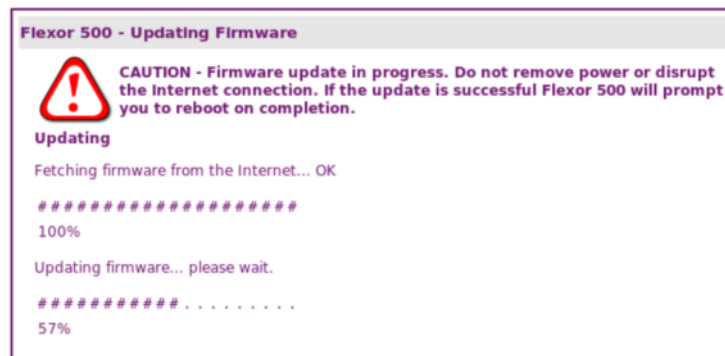

Step 4 – Firmware update complete

If the firmware update is successful you will see the following window:

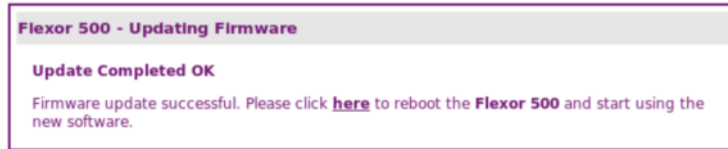

Click the [here](#) link to reboot the device and start using the new software.

Diagnostic messages

From the web pages

The device can run through a series of self-tests to check that every part of the system is working correctly. The tests include:

Perform a network check of all network connections, including the:

- ◆ Gateway and DNS Gateway.
- ◆ LAN port and PC port check
- ◆ DHCP server check
- ◆ NAT check
- ◆ VoIP Account information check

To perform the diagnostic checks, follow the procedure below:

- ◆ Select the Flexor 500 option from the main management web page.
- ◆ Click on the **Diagnostics** link at the top of the window.
- ◆ After a short pause while the checks are run a window is displayed containing a report about all the checks that have been run.

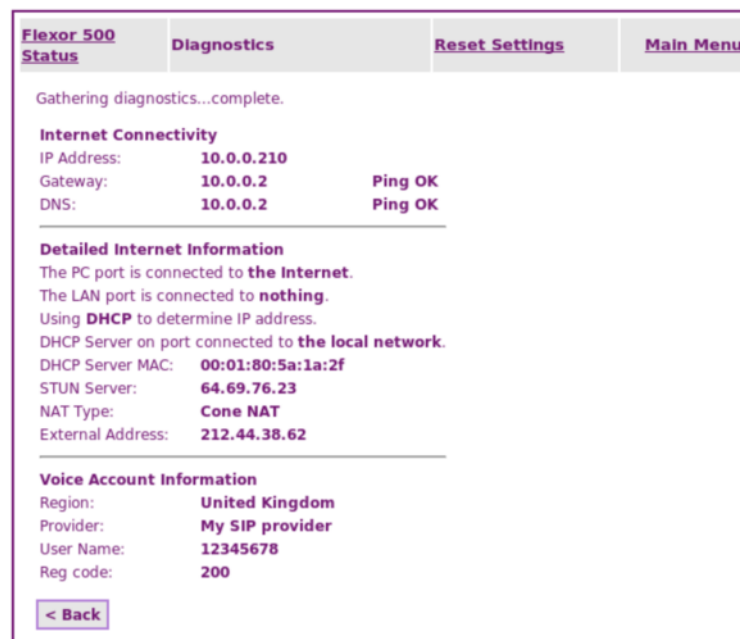

Normally, there should be no problems reported.

From the phone screen

The Flexor 500 shows the progress while starting up. If there are errors then these are shown as failures. In this case a soft key will be provided to enter the diagnostics screen to illustrate the error.

If the firmware starts up correctly but an error occurs later (e.g. a cable is unplugged) then a diagnostic message is shown at the bottom of the screen.

The screen below provides an example of this.



The following messages can be shown.

Message(s)	Explanation/Instructions
Ethernet unplugged	The Ethernet cable has been unplugged from the LAN connection. Check the cables are connected.
Firewall block	The Flexor 500 is plugged in correctly, however your LAN may be blocking Internet telephony traffic. Please check your LAN configuration.
Internet not found	The Flexor 500 is plugged in correctly, however there is a problem contacting your Internet Telephony Service provider. If you have a PC connected to the PC port of the Flexor 500, check that it can access the Internet. If the problem persists contact your Internet Telephony Service provider.
IP address not set	The network settings require an IP address to be dynamically allocated. Check the network settings and also that the DHCP server is configured to provide an address.
SIP not configured	The cables are plugged into your Flexor 500 correctly, and it is able to connect to your network, but you have not configured your VoIP account settings. Please see section <i>Configuring the device</i> on page 15 for instructions on how to configure your Flexor 500. You will not be able to make VoIP calls until a user name and password has been entered.
Invalid username	The cables are plugged into your Flexor 500 correctly, and it is able to connect to your network, and you have configured it. However, there is a problem with the configuration and you have likely made a mistake in the user name or password. See section <i>Modifying VoIP accounts</i> on page 46 for further information on how to re-enter your user name and password.

Message(s)	Explanation/Instructions
Invalid gateway	The network settings for the IP gateway are invalid. Check the IP address for the gateway.
Registering VoIP not available	The Flexor 500 is plugged in correctly, however there is a problem contacting your Internet Telephony Service provider. If you have a PC connected to the PC port of the Flexor 500, check that it can access the Internet. If the problem persists contact your Internet Telephony Service provider.

12 Installing the Voice Connect application

This appendix describes how to install the Voice Connect application software for Windows 2000 and Windows XP.

About the Voice Connect software

Before using the Flexor 500 it is recommended that you install the Voice Connect application on your PC. This application helps you to configure the Flexor 500 and after installation offers Computer Telephony Integration features (see section 6 for further information on CTI).

The Voice Connect application runs on any Microsoft Windows PC running the Microsoft .NET 2.0 framework. Most modern PCs already come with .NET pre-installed but if missing, it can be installed automatically during the installation process from the CD supplied.

Installing the Voice software

To install the CamrivoX Voice Connect software, follow the procedure below:

Step 1

- ◆ Turn on your computer.
- ◆ Insert the Voice Connect CD in your CD-ROM/DVD-ROM drive. Your CD should automatically start.

If the CD does not start automatically, browse the files on your computer in Windows Explorer, double-click on the CDROM drive, and double-click on the setup.bat program.

- ◆ If you do not have the Windows .NET framework installed on your PC, the following window is displayed:

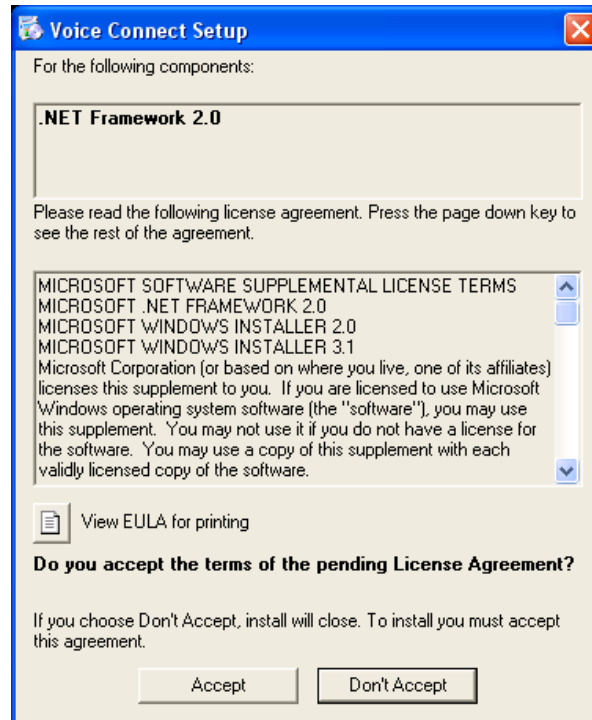

Click on Accept. The .NET Framework will be installed on your PC.



Note

The installation may take some time to complete.

Step 2

Once the .NET Framework is installed or if you do have the .NET Framework installed, the Voice Connect Setup Wizard window is displayed:

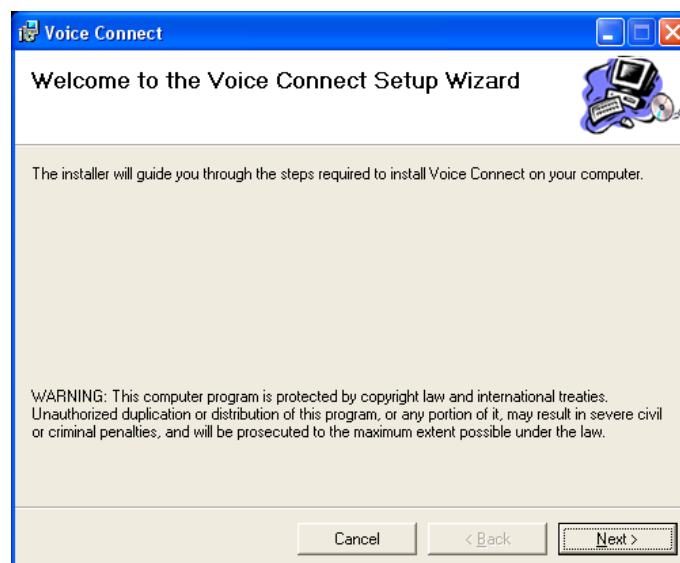

Click on *Next* to begin the installation of the Voice Connect software.

Step 3

The *Select Installation Folder* window is displayed:

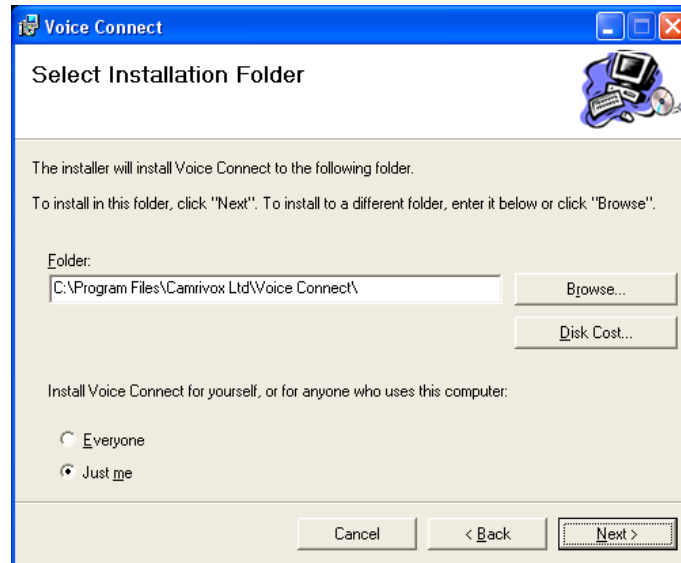

- ◆ Click on *Next* if you are happy with the settings shown in the window. To change the settings:
- ◆ Click on *Browse* to choose a new installation directory.
- ◆ Click on *Disk Cost* to view the amount of disk space used by the software.
- ◆ Click on *Everyone* if you wish to install the Voice Connect software for all users of the PC.

Step 4

The *Confirm Installation* window is then displayed, informing you that the software can now be installed. Click on *Next* to begin installing the software on your PC.

Step 5

When the installation has finished, the *Installation Complete* window is displayed confirming that the installation has been successful:

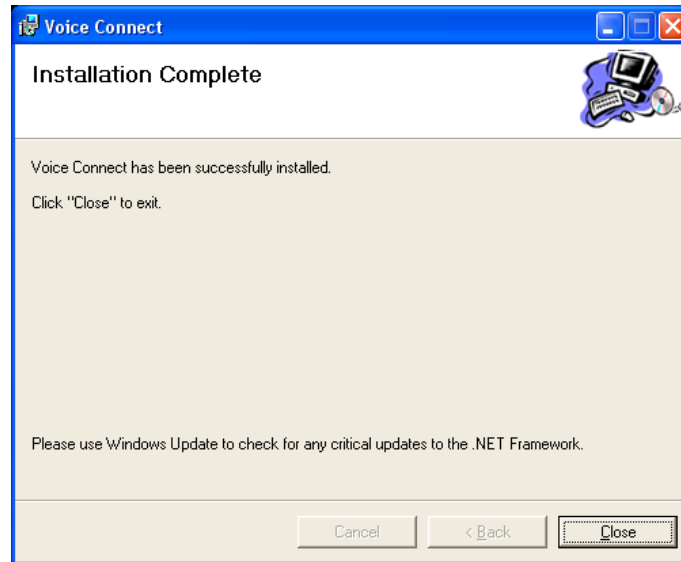

- ◆ Click on Close, to close the window.



Note

To use Windows Update to check for critical updates to the .NET Framework, start Internet Explorer and choose Tools > Windows Update.

Step 6

The Voice Connect application will now automatically start. The first time that the application runs you may see a warning similar to this from Windows Firewall or other firewall software that you are running:



Click **Unblock** to allow Voice Connect to access your network.

Step 7

A Voice Connect application icon will appear in the Windows icon tray in the bottom-right corner of your screen:



Now that the Voice Connect software is installed you can connect up and start using the device. For more information, refer to *Connecting the hardware* on page 15.

Uninstalling the software

There are two ways to uninstall the Voice Connect application. You can insert the installation CD a second time and a window will appear asking if you wish to remove the application. Alternatively, the Voice Connect application can be removed by going to the Windows Control Panel, going to Add/Remove programs and then removing Voice Connect.

13 Specification

This appendix provides a complete technical specification of all the features of the Flexor 500:

Feature	Specification
Interfaces	LAN Interface: Ethernet (10/100) PC Interface: Ethernet (10/100) Headset interface (2.5 mm.) Full duplex speakerphone LEDs: DND, MWI, Mute, Speaker, Headset, Line 1, Line 2, Line 3, Line 4
Management	Configuration, diagnostics, and firmware upgrade locally or by operator. HTTP/Web. Through built-in display.
Quality of Service (QoS)	Type of Service (ToS) Unique CamrivoX QoS features to prioritise voice traffic over PC data traffic. Power-On Self Test (POST) and diagnostics
Voice algorithms and protocols	SIP, RTP, SDP VAD, CNG, G.168 echo canceller, AEC Packet Loss Compensator G.711, G.726, G.729 Adaptive Jitter Buffer DTMF detection, generation, and relay
PBX features	Call hold, transfer, blocking, conference, and forwarding. Call history Caller ID
IP features	DHCP client, DNS client ICMP, TCP/UDP/IP NAT traversal and STUN SNTP HTTP RIP and RIPv2 802.1Q VLAN
Physical dimensions	Measurements: 170 x 180 x 90 mm Weight: 350grams
Environmental	5C - 40C operating temperature 5% - 90% non-condensing humidity
Power supply (external)	Input 100 - 240 VAC; 50/60 Hz; 0.5 A Output 5.0 VDC; 1.5 A

14 Copyright notices

This appendix contains all copyright notices associated with the Flexor 500.

CamrivoX

Copyright © 2007 CamrivoX Ltd, all rights reserved. The contents of this publication may not be reproduced in any part or whole, transcribed into any language, or transmitted in any form or by any means, electronics, mechanical, magnetic, optical, chemical, photocopying, manual, or otherwise, without the prior written permission of CamrivoX Ltd.

Vovida

CamrivoX products include software from Vovida Networks Inc, under the following conditions:

The Vovida Software License, Version 1.0

Copyright (c) 2000 Vovida Networks, Inc. All rights reserved.

Redistribution and use in source and binary forms, with or without modification, are permitted provided that the following conditions are met:

1. Redistributions of source code must retain the above copyright notice, this list of conditions and the following disclaimer.
2. Redistributions in binary form must reproduce the above copyright notice, this list of conditions and the following disclaimer in the documentation and/or other materials provided with the distribution.
3. The names "VOCAL", "Vovida Open Communication Application Library", and "Vovida Open Communication Application Library (VOCAL)" must not be used to endorse or promote products derived from this software without prior written permission. For written permission, please contact vocal@vovida.org.
4. Products derived from this software may not be called "VOCAL", nor may VOCAL appear in their name, without prior written permission of Vovida Networks, Inc.

THIS SOFTWARE IS PROVIDED "AS IS" AND ANY EXPRESSED OR IMPLIED WARRANTIES, INCLUDING, BUT NOT LIMITED TO, THE IMPLIED WARRANTIES OF MERCHANTABILITY, FITNESS FOR A PARTICULAR PURPOSE, TITLE AND NON-INFRINGEMENT ARE DISCLAIMED. IN NO EVENT SHALL VOVIDA NETWORKS, INC. OR ITS CONTRIBUTORS BE LIABLE FOR ANY DIRECT DAMAGES IN EXCESS OF \$1,000, NOR FOR ANY INDIRECT, INCIDENTAL, SPECIAL, EXEMPLARY, OR CONSEQUENTIAL DAMAGES (INCLUDING, BUT NOT LIMITED TO, PROCUREMENT OF SUBSTITUTE GOODS OR SERVICES; LOSS OF USE, DATA, OR PROFITS; OR BUSINESS INTERRUPTION) HOWEVER CAUSED AND ON ANY THEORY OF LIABILITY, WHETHER IN CONTRACT, STRICT LIABILITY, OR TORT (INCLUDING NEGLIGENCE OR OTHERWISE) ARISING IN ANY WAY OUT OF THE USE OF THIS SOFTWARE, EVEN IF ADVISED OF THE POSSIBILITY OF SUCH DAMAGE.

This software consists of voluntary contributions made by Vovida Networks, Inc. and many individuals on behalf of Vovida Networks, Inc. For more information on Vovida Networks, Inc., please see <http://www.vovida.org/>

Internet Software Consortium

CamrivoX products include software from the Internet Software Consortium, under the following conditions:

Copyright (c) 1995, 1996, 1997, 1998 The Internet Software Consortium.
All rights reserved.

Redistribution and use in source and binary forms, with or without modification, are permitted provided that the following conditions are met:

1. Redistributions of source code must retain the above copyright notice, this list of conditions and the following disclaimer.
2. Redistributions in binary form must reproduce the above copyright notice, this list of conditions and the following disclaimer in the documentation and/or other materials provided with the distribution.
3. Neither the name of The Internet Software Consortium nor the names of its contributors may be used to endorse or promote products derived from this software without specific prior written permission.

THIS SOFTWARE IS PROVIDED BY THE INTERNET SOFTWARE CONSORTIUM AND CONTRIBUTORS ``AS IS'' AND ANY EXPRESS OR IMPLIED WARRANTIES, INCLUDING, BUT NOT LIMITED TO, THE IMPLIED WARRANTIES OF MERCHANTABILITY AND FITNESS FOR A PARTICULAR PURPOSE ARE DISCLAIMED. IN NO EVENT SHALL THE INTERNET SOFTWARE CONSORTIUM OR CONTRIBUTORS BE LIABLE FOR ANY DIRECT, INDIRECT, INCIDENTAL, SPECIAL, EXEMPLARY, OR CONSEQUENTIAL DAMAGES (INCLUDING, BUT NOT LIMITED TO, PROCUREMENT OF SUBSTITUTE GOODS OR SERVICES; LOSS OF USE, DATA, OR PROFITS; OR BUSINESS INTERRUPTION) HOWEVER CAUSED AND ON ANY THEORY OF LIABILITY, WHETHER IN CONTRACT, STRICT LIABILITY, OR TORT (INCLUDING NEGLIGENCE OR OTHERWISE) ARISING IN ANY WAY OUT OF THE USE OF THIS SOFTWARE, EVEN IF ADVISED OF THE POSSIBILITY OF SUCH DAMAGE.

This software has been written for the Internet Software Consortium by Ted Lemon <mellon@fugue.com> in cooperation with Vixie Enterprises. To learn more about the Internet Software Consortium, see ``<http://www.vix.com/isc>'' . To learn more about Vixie Enterprises, see ``<http://www.vix.com>''